

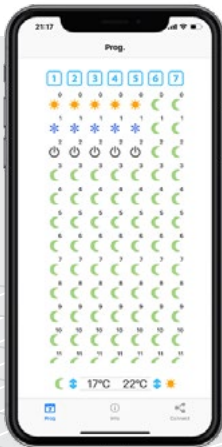

SIMPLY



Manual de instalación y uso
Instructions & installation manual
Manuel d'installation et utilisation
Manual de instalação e uso



HAVERLAND
APP



Español

English

Français

Português



4	1. ADVERTENCIAS GENERALES
6	2. INSTALACIÓN
9	3. FUNCIONAMIENTO
9	3.1 PANEL DE CONTROL
9	3.2 MODO MANUAL
10	3.3 MODO AUTO “BLUETOOTH®”
14	3.4 DESCONEXIÓN RED ELÉCTRICA / CORTE SUMINISTRO
15	3.5 FUNCIÓN INTELIGENTE ITCS
15	3.6 FUNCIÓN AHORRO “VENTANAS ABIERTAS”
15	4. MANTENIMIENTO

16	1. GENERAL WARNINGS
18	2. INSTALLATION
21	3. OPERATION
21	3.1 CONTROL PANEL
21	3.2 MANUAL MODE
22	3.3 AUTO MODE (BLUETOOTH®)
26	3.4 DISCONNECTION FROM THE ELECTRICITY / POWER CUT
27	3.5 INTELLIGENT ITCS FUNCTION
27	3.6 “OPEN WINDOWS” SAVE FUNCTION
27	4. MAINTENANCE

28	1. AVERTISSEMENTS GÉNÉRAUX
30	2. INSTALLATION
33	3. FONCTIONNEMENT
33	3.1 PANNEAU DE COMMANDE
33	3.2 MODE MANUEL
34	3.3 MODE AUTO (BLUETOOTH®)
38	3.4 DÉCONNEXION DU RÉSEAU ÉLECTRIQUE / COUPURE D'ÉLECTRICITÉ
39	3.5 FONCTION INTELLIGENTE ITCS
39	3.6 FONCTION ÉCONOMIE "FENÊTRES OUVERTES"
39	4. ENTRETIEN

40	1. ADVERTÊNCIAS GERAIS
42	2. INSTALAÇÃO
45	3. FUNCIONAMENTO
45	3.1 PAINEL DE CONTROLO
45	3.2 MODO MANUAL
46	3.3 MODO AUTO (BLUETOOTH®)
50	3.4 DESLIGAR DA REDE ELÉTRICA / CORTE ABASTECIMENTO
51	3.5 FUNÇÃO INTELIGENTE ITCS
51	3.6 FUNÇÃO ECONOMIA "JANELAS ABERTAS"
51	4. MANUTENÇÃO

- **Por favor, lea estas instrucciones detenidamente.**
- Para desconectar el emisor de la red eléctrica saque la clavija de alimentación del enchufe. **Nunca tire del cable.**
- No dejar el cable de conexión en contacto con el aparato mientras esté encendido.
- **La garantía del aparato no cubrirá cualquier daño causado por la no lectura de estas instrucciones.**



PELIGRO: NO CUBRIR EL APARATO. NO LO USE PARA SECAR ROPA. Si se cubre, existe el riesgo de producirse un sobrecalentamiento.



• **PELIGRO: Si el cable de alimentación está dañado, debe ser sustituido por el fabricante, por su Servicio Postventa o por personal cualificado similar.**



• **PELIGRO: Si el aparato se va a instalar en un cuarto de baño, debe ser instalado de tal manera que no pueda ser tocado por cualquier persona que se encuentre en la bañera o ducha.**



• **La instalación debe ser efectuada teniendo en cuenta estas instrucciones y acorde a la legislación eléctrica vigente.**

• El aparato no debe estar situado debajo o delante de una toma de corriente.

• La instalación debe ser efectuada según la legislación eléctrica vigente.

• Este aparato debe ser conectado a tierra.

• El emisor debe ser instalado de tal manera que la clavija de alimentación sea siempre accesible.

• **Este emisor térmico es un aparato para fijarlo a la pared. Este emisor no se debe encastrar. Respetar siempre las distancias de seguridad.**

• Durante su funcionamiento, debe tenerse la precaución de mantener el aparato alejado de materiales combustibles tales como cortinas, moquetas, muebles, etc.

- Este aparato no está pensado para ser usado por personas (incluidos niños) con capacidades físicas reducidas, sensoriales o mentales, con poca experiencia o conocimiento, al menos que estén bajo supervisión de una persona responsable de su seguridad con las instrucciones de uso del aparato. Los niños deben ser supervisados para asegurar que no juegan con el aparato.

- Los niños menores de 3 años deben mantenerse fuera del alcance del aparato a menos que sean continuamente supervisados. Los niños desde 3 años y menores de 8 años deben sólo encender/apagar el aparato siempre que éste haya sido colocado o instalado en su posición de funcionamiento normal prevista y que sean supervisados o hayan recibido instrucciones relativas al uso del aparato de una forma segura y entiendan los riesgos que el aparato tiene.

- Los niños desde 3 años y menores de 8 años no deben enchufar, regular y limpiar el aparato o realizar operaciones de mantenimiento.

- Este aparato puede ser usado por niños mayores de 8 años y por personas con discapacidades físicas, sensoriales o mentales, o sin experiencia o conocimientos, siempre y cuando hayan sido debidamente formados y sean supervisados por alguien que entienda los riesgos.

- La limpieza y el mantenimiento a realizar por el usuario no se deben hacer por niños. Los niños no deben jugar con el aparato.

- **PRECAUCIÓN: Algunas partes de este producto pueden ponerse muy calientes y causar quemaduras.** Debe ponerse atención particular cuando los niños y las personas vulnerables estén presentes.



- No tocar las partes externas del emisor cuando esté en funcionamiento.

- Antes del primer arranque o antes del comienzo de la campaña de invierno o cuando el emisor no se ha usado durante muchos días, el aparato debe ser limpiado (siga los pasos del punto “mantenimiento” de este manual.

- Es normal que en las primeras puestas en marcha, el aparato produzca olores. Ponga en marcha el aparato en un lugar ventilado

durante 2 ó 3 horas.

- **PRECAUCIÓN:** Para evitar riesgos de asfixia, no dejar las bolsas y demás accesorios al alcance de bebés y niños.



- Este emisor **NO puede funcionar** con centralitas externas programables o cualquier otro dispositivo de control exterior.

- El efecto de la convección, junto a otros factores ambientales, puede causar **decoloración en las superficies metálicas y en los plásticos.**

- Los contrastes de temperatura pueden generar “chasquidos” o ruidos en el aparato. Esto no es un fallo del emisor, sino que se debe a la dilatación/contracción del aluminio.

- Cuando se desechen los emisores, deben tenerse en cuenta los requisitos establecidos por la legislación para el tratamiento y reciclaje de los residuos.



IMPORTANTE

- Es indispensable que el emisor **SE FIJE FIRMEMENTE A UNA PARED ESTABLE Y NIVELADA.**
- Comprobar que exista un enchufe cerca de donde lo vaya a situar.
- Saque del interior de la caja de embalaje la plantilla donde se indica la posición de los taladros para colocar el aparato a la pared.
- Para evitar problemas es necesaria una distancia mínima de 15 cm entre el emisor y cualquier material.

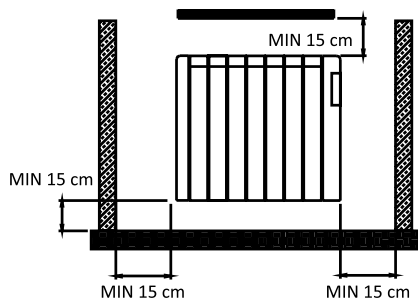

1

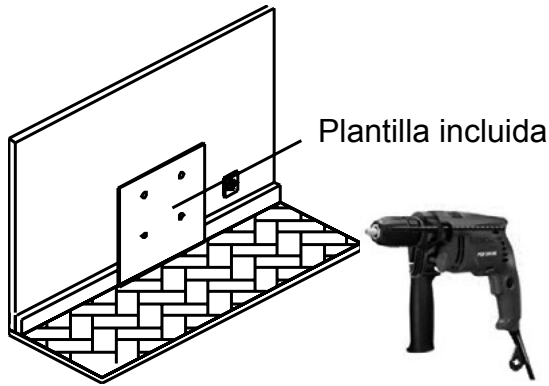

2

Atornille hasta tocar la patilla inferior (M. 6 x 40 mm)

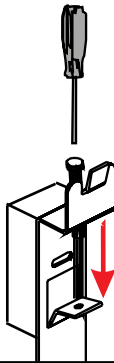

3

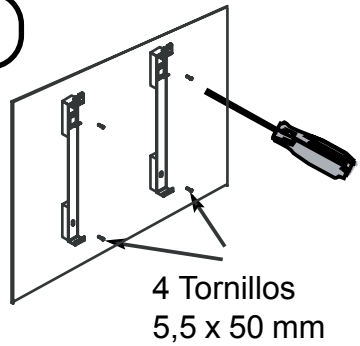

4

Apoye el emisor



5

1. Colocar
2. Caer
3. Apoyar

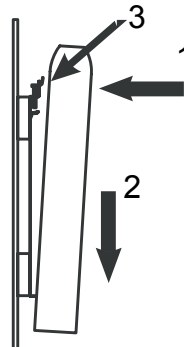

6

**IMPORTANTE:**

Atornille completamente para fijar el emisor

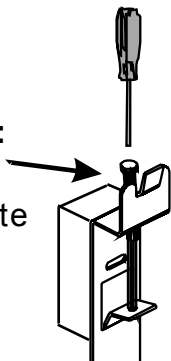

7

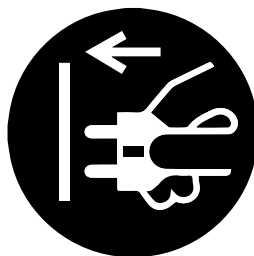

8

Pulsar el interruptor situado en el lateral derecho

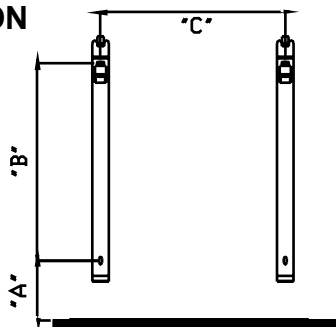
**INFORMACIÓN**

(W)	"A" (mm)	"B" (mm)	"C" (mm)
600	420	246	159
900	420	246	319
1200	420	246	478
1500	420	246	638
1800	420	246	638

3.1 PANEL DE CONTROL

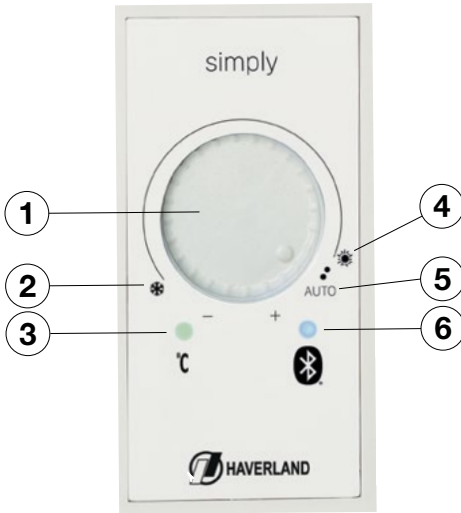

1. Mando Termostato Electrónico
2. Modo Antihielo
3. Piloto "Indicador Temperatura"
4. Modo Confort
5. Modo AUTO "Bluetooth®"
6. Piloto "Indicador Bluetooth®"

3.2 MODO MANUAL

* Pulse el interruptor situado en el lado derecho. El aparato lleva incorporado un termostato electrónico que controla la temperatura.

* Se encenderá el piloto luminoso indicando que el radiador está funcionando.

* Para determinar la temperatura de consigna, gire el mando del termostato electrónico a la posición deseada.

El termostato electrónico mantendrá constante la temperatura de la estancia.

* El termostato está dotado de posición anti-hielo. Con el mando del termostato en la posición mínima, el aparato se pondrá en funcionamiento cuando la temperatura ambiente descienda de los 5°C.

NOTA 1



El color del piloto "Indicador Temperatura" cambiará cuando la temperatura de consigna se modifique, indicando el rango de temperatura seleccionado y se mostrará:

- **Rojo** si la temperatura es mayor de 24°C
- **Amarillo** si es mayor de 19°C hasta 24°C
- **Verde** si es igual o menor a 19°C
- **Azul** si es igual o menor de 5°C

3.3 MODO AUTO "BLUETOOTH®"

Haverland ha desarrollado una App sencilla y funcional para que pueda realizar un programa semanal, día a día, hora a hora.

Descargue la aplicación "**Haverland BT**" en su smartphone y/o tablet desde AppleStore (iOS) o en Google Play (Android).



HAVERLAND BT



NOTA 2



Asegúrese de que la app descargada sea la indicada.

1



HAVERLAND BT

2

Pantalla inicio

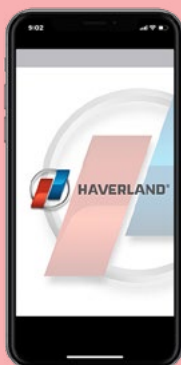

3

Pantalla programación

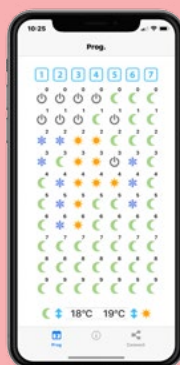

4

Elija las temperaturas de confort y economía.



5

Pulsando **sucesivamente** sobre los símbolos, elija el modo funcionamiento deseado para cada hora y día.



NOTA 3

Para facilitarle la programación, puede copiar el programa realizado un día a los días siguientes que se desee.

Pulsar sobre el día a copiar (por ejemplo, lunes "1").

Pulsar sobre los días a copiar (por ejemplo, martes, miércoles y jueves).

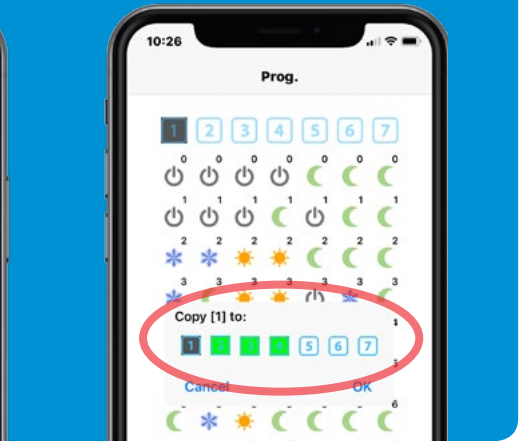

- 6** Pulsar sobre la tecla "Connect" para pasar a la pantalla "Conexión".



- 7**
- Activa Bluetooth para permitir que "Haverland_BT" se conecte a los accesorios

Ajustes OK

Active su conexión BT.

- 8** Girar mando posición auto. El piloto "Indicador Bluetooth®" parpadeará.

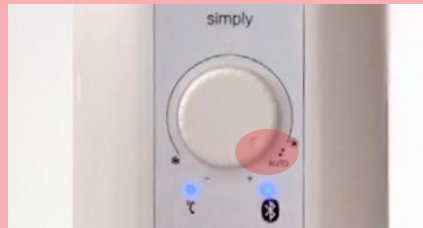

IMPORTANTE:

Si el piloto "Bluetooth®" no parpadea, gire el mando a la izquierda y vuelva a posición AUTO.

9

Pulsar

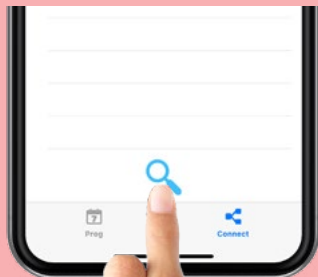

10

A continuación, el aparato aparecerá en su smartphone. Pulse sobre el indicativo “HAVERLAND”. Aparecerá un rectángulo gris.

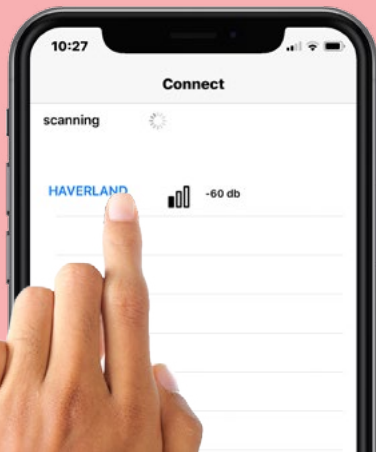

11

El radiador está enlazado con su smartphone o tablet.

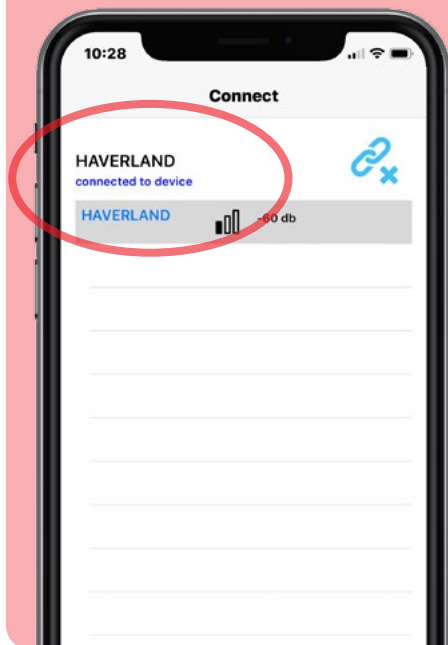

12

Para finalizar, “envíe” el programa configurado a su radiador pulsando:

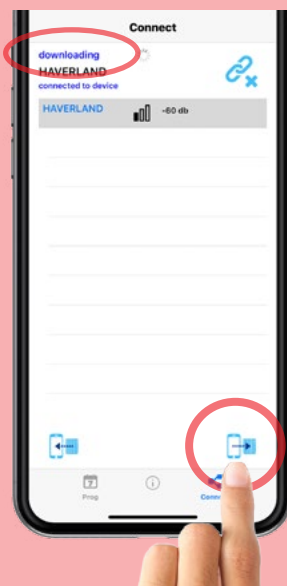
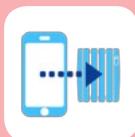

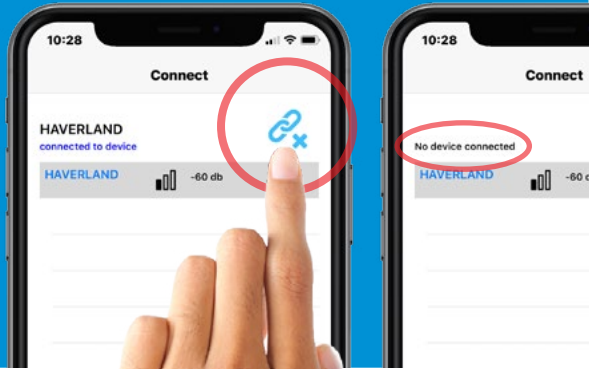

NOTA 4

 Para configurar otro radiador, **desconecte el radiador actual del smartphone o tablet**, pulsando en la app:



NOTA 5

 Una vez enviado el programa al aparato, **el radiador pasará a modo automático**, sea cual sea el modo de funcionamiento en curso, incluido el modo "anti-hielo".

 El indicador luminoso azul "Bluetooth®" fijo indican que el radiador está en **modo AUTOMÁTICO**.



NOTA 6

 Si no recuerda el programa que está configurado en su radiador, puede "recuperarlo" y verlo en la pantalla PROGRAMACIÓN, pulsando:

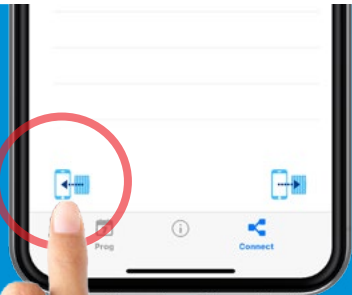

NOTA 7



Recuerde que para enlazar su dispositivo móvil con su radiador debe:

Pulsar



y girar el mando a AUTO

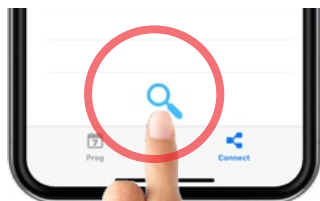

3.4 DESCONEXIÓN RED ELÉCTRICA / CORTE SUMINISTRO

Si el radiador se mantiene desconectado de la red eléctrica (interruptor del emisor desconectado) o si se produce un corte del suministro eléctrico **superior a 2 horas, DEBE ACTUALIZAR EL RELOJ Y EL DÍA DE LA SEMANA.**

Se mantiene en memoria el resto de los parámetros programados (temperaturas y programación).

PARA ACTUALIZAR EL RELOJ Y EL DÍA DE LA SEMANA:

Si tiene descargada la App **"Haverland BT"**, enlace su dispositivo móvil a su radiador (**sigua el punto**

anterior 6) y pulse en la App



El reloj se actualizará vía internet.

3.5 FUNCIÓN INTELIGENTE ITCS

El radiador incorpora un **innovador sistema de control inteligente de temperatura ITCS**.

Este sistema activa la puesta en marcha del aparato con **antelación a la hora programada** (2 horas máximo), para asegurar que se consigue la temperatura deseada a la hora indicada y siguiendo el programa semanal establecido.

NOTA 8



Esta función está solo disponible en modo AUTO.

3.6 FUNCIÓN AHORRO “VENTANAS ABIERTAS”

Esta función se activa cuando se produce un descenso brusco de la temperatura en la habitación.

NOTA 9



Al activarse esta función, se encenderá el piloto luminoso “temperatura” en azul (modo antihielo).

El aparato se desconectará evitando un consumo de energía innecesario.

Al cerrar la ventana, el radiador detectará una subida de temperatura y se desactivará esta función o gire el mando a la izquierda y vuelva a la posición AUTO.

El aparato se encenderá de nuevo volviendo al estado anterior a la desconexión.

NOTA 10



Esta función está solo disponible en modo AUTO.

4. MANTENIMIENTO

Su aparato no precisa de ningún tipo de mantenimiento especial.

Solamente limpie el polvo que se pueda acumular con un trapo seco y suave.

Es conveniente al comenzar la temporada de invierno, limpiar el polvo acumulado sobre la superficie del radiador.



NUNCA UTILICE DISOLVENTES NI PRODUCTOS ABRASIVOS.

- **Please read these instructions carefully.**
- To disconnect mains power from the radiator remove the plug from the wall socket, but **never pull on the cable.**
- Do not leave the mains cable in contact with the radiator when it is switched on.
- During operation, the radiator must be kept well away from combustible materials, such as curtains, carpets and furniture etc.
- **The warranty for the radiator does not cover any damage caused by not reading these instructions.**



WARNING: In order to avoid overheating, do not cover the heater.



• **WARNING: If the mains power cable is damaged, it must be replaced by the manufacturer, with their after-sales service or similar qualified persons, in order to prevent any danger.**



• **WARNING: If the heater is to be installed in a bathroom, it must be positioned so that it cannot be touched by anybody in the bath or shower.**



• **The installation should be carried out with consideration to the manufacturer's instructions and in accordance to the relevant National Wiring Regulations BS7671.**

• It is very important that radiator has a good Electric Earth connection.

• The radiator shall be installed so that its mains plug is always accessible.

• The radiator must not be installed below or in front of a mains socket.

• **This radiator cannot be surface-mounted with a wall. Safety distances shall always be respected.**

- This unit is not designed to be handled by persons (including children) with physical, sensorial or mental handicaps, with little experience or knowledge unless they are under the supervision of an adult responsible for their safety with the instructions on its use. Children shall always be supervised to ensure they do not play with the unit.
- Children under three shall be kept well away from the heater unless they are continually supervised.
- Children between three and eight shall only switch the unit off or on providing it is positioned or installed in its final operating location and be supervised or have received instructions on how to use the unit in a safe manner and understand the risks involved.
- Children between three and eight shall not plug in, adjust or clean the heater or carry out any maintenance operations.
- This unit may be used by children older than eight and by persons with physical, sensorial or mental handicaps, with little experience or knowledge, provided they have been duly trained and are supervised by an adult that understands the risks involved.
- Cleaning and maintenance shall be performed by adults not children. Children must not play with the unit.
- **WARNING: Certain parts of this product can become very hot and cause burns.** Special attention shall be paid when children and other vulnerable persons are present.
- Do not touch the external parts of the radiator when it is operating.
- It is quite normal that, with the first switch-on, the unit produces a “new” smell. Allow your heater to operate in a well-ventilated place for two or three hours.
- Before the first switch on for the coming winter or when the heater has not been used for several days, the unit should be



cleaned (follow the steps given in the “maintenance section”. This cleaning operation will avoid burning the accumulated dust and other remains.

- This radiator **CAN'T OPERATE** with external programmable controllers or any other exterior control device.



- **CAUTION:** Keep bags and other accessories well out of the reach of children.

- The convection effect, together with other ambient factors, can cause discolouring to metal surfaces and to plastics.

- Temperature differences can cause crackling and other noises in the unit. This does not indicate any failure in the radiator.

- When the radiator is disposed of, the requirements established by current legislation on waste processing and recycling shall be taken into account.



IMPORTANT

- It is important that the radiator **IS FIXED FIRMLY TO A SOLID AND LEVELLED WALL**.

- Make sure that there is a socket near the area where you are going to place it.

- Take out the wall pattern from the box to see the exact positions of the necessary drill holes.

- You must keep a minimum distance of 15 cm between the radiator and any object, wall or combustible material.

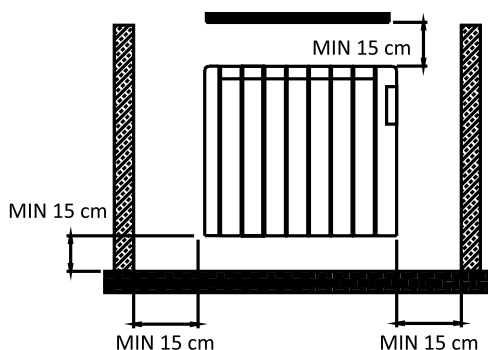

1

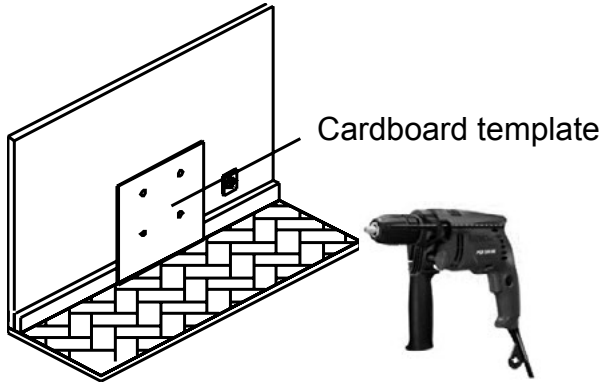

2

Place the screw
but don't
screw it fully.
(M. 6 x 40 mm)

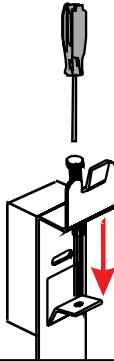

3

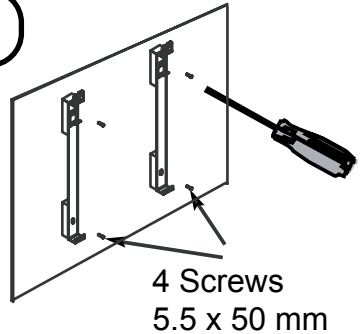

4

Place
the radiator

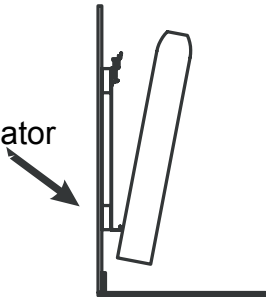

5

Slide the
radiator up,
Place over top
tang and lower
gently into
position

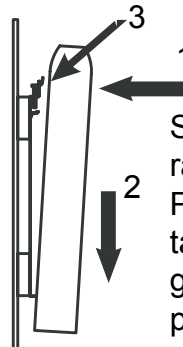

6



IMPORTANT:
Screw down
FULLY to lock
the radiator

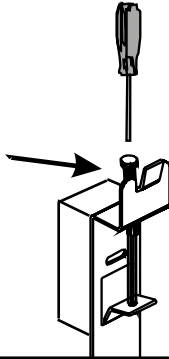

7

Plug in
3 pin 13 amp
plug

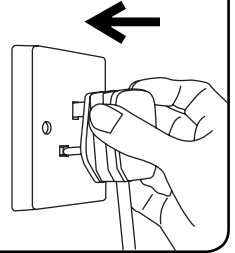

8

Press ON /
OFF switch
located at the
right rear part
of the unit.

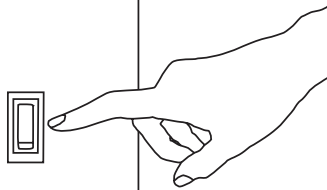

INFORMATION

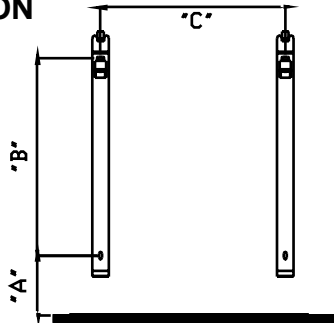

(W)	"A" (mm)	"B" (mm)	"C" (mm)
600	420	246	159
900	420	246	319
1200	420	246	478
1500	420	246	638
1800	420	246	638

3.1 CONTROLS

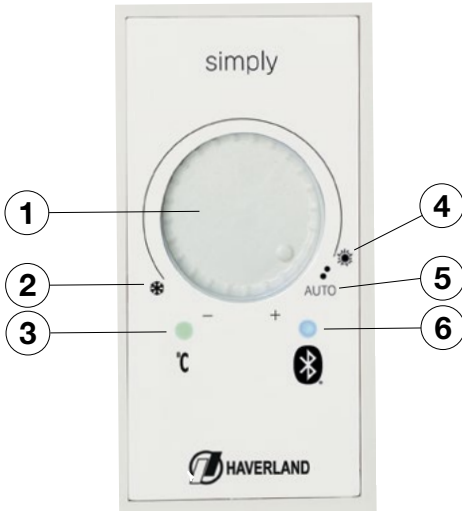

1. Ambient Thermostat Knob
2. Antifreeze Mode
3. "In operation" Indicator LED
4. Comfort Mode
5. AUTO "Bluetooth®" Mode
6. "Bluetooth®" Indicator LED

3.2 MANUAL MODE

* Press the ON/OFF button located on the right side. The appliance has a built in thermostat that can be regulated and it controls the temperature.

* The "In operation" indicator LED will turn on indicating that the radiator is working.

* To settle the room temperature, turn the electronic thermostat control knob to the desired position.

The electronic thermostat will maintain a constant temperature.

* The thermostat has an antifreeze position. With the thermostat control at minimum, the appliance will start working when the room temperature goes down to 5°C.

NOTE 1



The background colour of the "in operation" indicator LED will change when the pre-set temperature is modified or changed, indicating the selected temperature range to the user by showing:

- **Red** if the temperature is over 24°C
- **Yellow** if it is higher than 19° and up to 24°C
- **Green** if it is equal to or lower than 19°C
- **Blue** if it is equal to or lower than 5°C

3.4 AUTO "BLUETOOTH®" MODE

Haverland has developed a simple and functional App so that you can make a weekly program, day by day, hour by hour.

Download "**Haverland BT**" the application on your smartphone and / or tablet from the AppleStore (iOS) or Google Play (Android).



NOTE 2



Make sure you download the correct App as indicated.

1



HVERLAND BT

2

Start Screen



3

Programming Screen

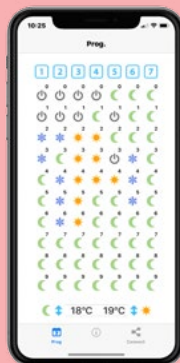

4

Choose comfort and economy temperatures.



5

By pressing successively on the icons, choose the operating mode required for each hour and day.

NOTE 3



To facilitate programming, you can copy the program made one day to the next days that you want.

Press on the day to be copied (for example, Monday “1”).

Press on the days to be copied (for example, Tuesday, Wednesday and Thursday).

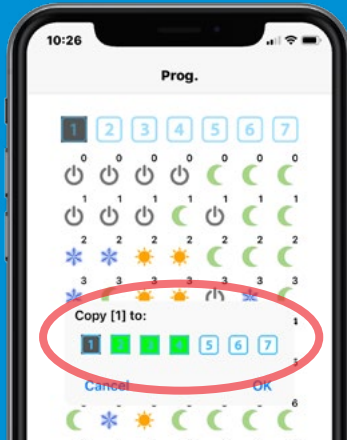

6

Press on the “Connect” button to reach the “Connection” screen.

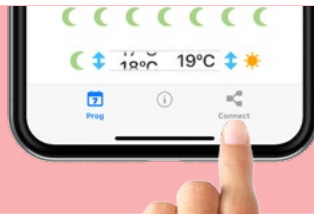

7

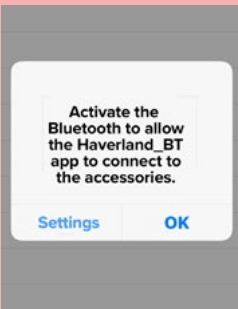

Activate your BT connection.

8

Turn the thermostat control knob to the AUTO position. The “Bluetooth®” LED will flash.



IMPORTANT:
If the “Bluetooth®” LED does not flash, turn the knob counterclockwise and return to the AUTO position.

9

Press

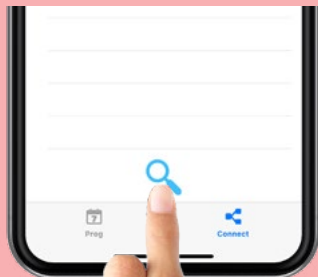

10

Then, the radiator will be displayed on your smartphone. Press on "HAVERLAND" the radiator will be selected (grey background).

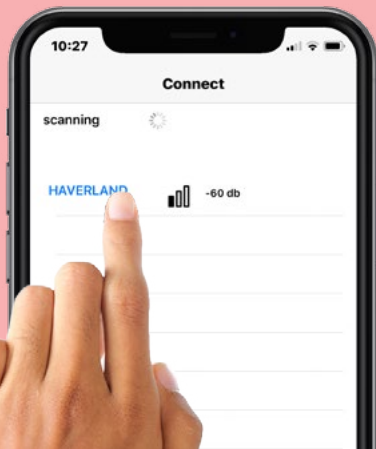

11

The radiator is linked with your smartphone or tablet.

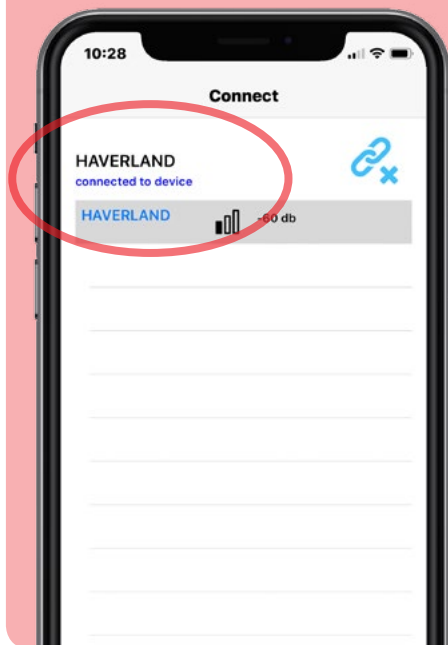

12

To finish, "send" the configured program to your radiator by pressing:

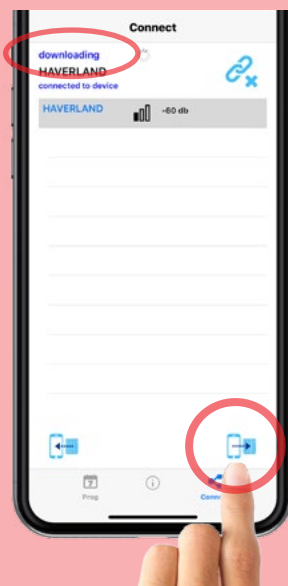
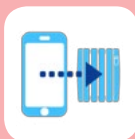

NOTE 4



To disconnect the radiator from your smartphone or tablet and to set other radiator, press:

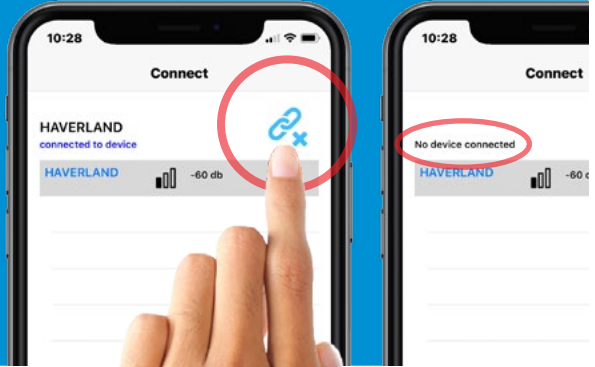

NOTE 5



Once the program has been sent to the device, **the radiator will switch to automatic mode**, whatever the current mode of operation is, including the “anti-frost” mode.



The “BLUETOOTH®” indicator LED indicate that the radiator is in **AUTOMATIC mode** and is connected to your smartphone.



NOTE 6



If you do not remember the program that is set on your radiator, you can “recover it” and look it up in the PROGRAMMING screen, by pressing:

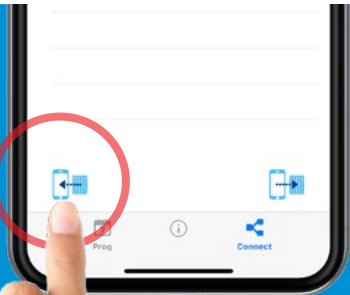

NOTE 7



Remember that to link your mobile device with your radiator you must:

Press



and turn the knob in AUTO position

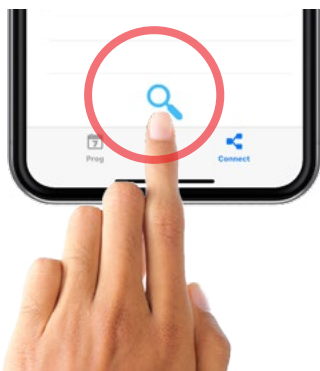

3.5 DISCONNECTING THE MAINS SUPPLY / SUPPLY CUT OFF

If the radiator is kept disconnected from the mains or if there is a mains supply cut off for **more than 2 hours, YOU MUST UPDATE THE CLOCK AND THE DAY OF THE WEEK.**

The rest of the programmed parameters (temperatures and programming) are kept in memory.

TO UPDATE THE CLOCK AND THE DAY OF THE WEEK:

If you have downloaded the “Haverland BT” App, link your mobile device to your radiator (**follow the**

previous point 6) and click on the App



The clock and day will be updated via the internet.

3.5 ITCS INTELLIGENT FUNCTION

The radiator incorporates an **innovative ITCS smart temperature control system**.

This system activates the **start-up of the device in advance of the scheduled time** (2 hours maximum), ensuring that the desired temperature is achieved at the specified time and following the weekly schedule set.

NOTE 8



This intelligent function is only available in AUTO mode.

3.6 "OPEN WINDOW" FUNCTION

This function is activated when there is a sudden drop in the temperature in the room.

NOTE 9



When this function is activated, the "In operation" Indicator LED appears on blue (Anti-freeze Mode).

The radiator will be switched off avoiding unnecessary energy consumption.

When closing the window, the radiator will detect a temperature rise or turn the thermostat control knob to the left and turn again the thermostat control knob to the AUTO position and this function will be deactivated. The radiator will switch on again, returning to the state before the disconnection.

NOTE 10



This intelligent function is only available in AUTO mode.

4. MAINTENANCE

Your device does not require any type of special maintenance.

You need only clean any dust that may accumulate with a dry and soft cloth.

We advise that you clean any accumulated dust from the radiator surface at the beginning of the winter season.



NEVER USE SOLVENTS OR ABRASIVE PRODUCTS.

- **Veillez lire les instructions explicatives.**
- Pour déconnecter le radiateur du réseau électrique, retirez le câble d'alimentation de la prise de courant. **Ne jamais tirer du câble électrique.**
- Ne pas laisser le câble de connexion en contact avec l'appareil pendant qu'il est allumé.
- **La garantie de l'appareil ne tiendra pas en compte des dommages causés par la non lecture de ces instructions.**



DANGER: NE PAS COUVRIR L'APPAREIL. NE PAS L'UTILISER POUR SÉCHER LE LINGE.
Le couvrir occasionnerait un danger, car il pourrait se produire une surchauffe.



• **DANGER:** Si le câble d'alimentation s'abîme il faudra le faire remplacer par un Service Technique Autorisé afin d'éviter un risque quelconque.



• **DANGER:** Si l'appareil va être installé dans une salle de bain, il doit être placé de telle sorte que l'appareil ne puisse pas être touché par n'importe quelle personne qui se trouve dans la baignoire ou la douche.



• **L'installation doit être effectuée selon les instructions du fabricant et conformément à la législation électrique en vigueur.**

• L'appareil ne doit pas être placé en dessous ou devant une prise de courant.

• Pendant son fonctionnement, il faudra prendre la précaution de maintenir éloigné l'appareil de matériaux combustibles tels que rideaux, moquettes, meubles, etc.

• L'installation doit être effectuée selon la législation électrique en vigueur.

• Cet appareil doit être connecté à une prise de terre.

• Le radiateur doit être installé de telle manière que le câble électrique d'alimentation soit parfaitement accessible.

• **Cet radiateur est un appareil qui doit être fixé au mur. Ce radiateur ne doit pas être encastré. Respectez toujours les distances de**

sécurité.

- Cet appareil n'est pas conçu pour être utilisé par des personnes (y compris les enfants) ayant des capacités physiques, sensorielles ou mentales réduites, avec peu d'expérience ou de connaissance, à moins qu'elles ne soient sous la supervision d'une personne responsable de leur sécurité, avec les instructions d'usage de l'appareil. Les enfants doivent être supervisés pour s'assurer qu'ils ne jouent pas avec l'appareil.
- Les enfants âgés de moins de 3 ans doivent se maintenir hors de portée de l'appareil, à moins qu'ils ne soient continuellement supervisés.
- Les enfants de 3 ans à 8 ans peuvent allumer / éteindre l'appareil, seulement si celui-ci a été placé ou installé dans sa position de fonctionnement normal prévue, et s'ils sont supervisés ou qu'ils ont reçu des instructions relatives à l'usage de l'appareil de façon sûre, et aient les risques que renferme l'appareil.
- Les enfants de 3 ans à 8 ans ne doivent pas brancher, ni régler, ni nettoyer l'appareil ni réaliser des opérations de maintenance.
- Cet appareil peut être utilisé par les enfants à partir de 8 ans et les personnes avec capacités physiques, sensorielles ou mentales réduites avec peu d'expérience et de connaissance, si elles ont reçu la supervision ou la formation convenable en ce qui concerne l'utilisation de l'appareil de façon sûre et qu'elles comprennent les dangers qu'il implique. Le nettoyage et la maintenance à réaliser par l'utilisateur ne doivent pas être effectués par des enfants. Les enfants ne doivent pas jouer avec l'appareil.
- **PRÉCAUTION : Certaines parties de ce produit peuvent devenir très chaudes et provoquer des brûlures.**



- Avant chaque saison hivernale, ou si l'appareil a été débranché pendant plusieurs jours, nettoyez l'appareil avant de le connecter (suivez les étapes "section Maintenance"). Avec ledit nettoyage, vous éviterez de faire brûler la poussière accumulée et autres restes.
- Il est normal que, lors du premier démarrage, l'appareil puisse dégager une odeur. Faites fonctionner votre émetteur dans un lieu

ventilé pendant 2 ou 3 heures.

- Il faudra y accorder une attention particulière lorsque des enfants et/ou des personnes vulnérables seront présents.
- Évitez de toucher les parties externes de l'émetteur pendant son fonctionnement.
- Le radiateur **NE peut pas fonctionner** avec des centrales externes de programmation ou tout autre dispositif de contrôle extérieur.
- **PRÉCAUTION** : Pour éviter tout danger d'asphyxie, gardez ce sac en plastique hors de portée des bébés et des enfants.
- L'effet de la convection, conjointement avec d'autres facteurs environnementaux, peut provoquer une décoloration dans les surfaces métalliques et plastiques.
- Les contrastes de température peuvent générer "des craquements" ou des bruits dans l'appareil. Ceci n'est pas une défaillance du radiateur.
- Au moment de jeter les radiateurs, il faudra tenir compte des exigences requises par la législation pour le traitement et recyclage des résidus.



IMPORTANT

- Il est indispensable **FIXER FERMEMENT le radiateur A UN MUR SOLIDE ET NIVELÉ.**
- Vérifier qu'il y a une prise de courant proche de l'endroit où vous souhaitez le situer.
- Prenez de l'intérieur de la boîte d'emballage le patron qui indique la position exacte.
- Pour éviter des problèmes, la distance minimum de 15 cm est nécessaire entre le radiateur et tout autres matériaux.

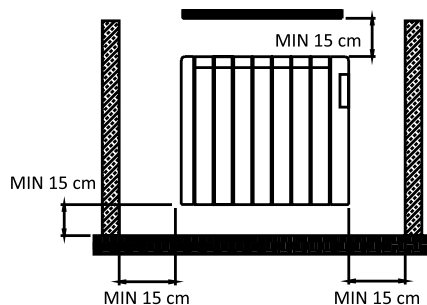

1

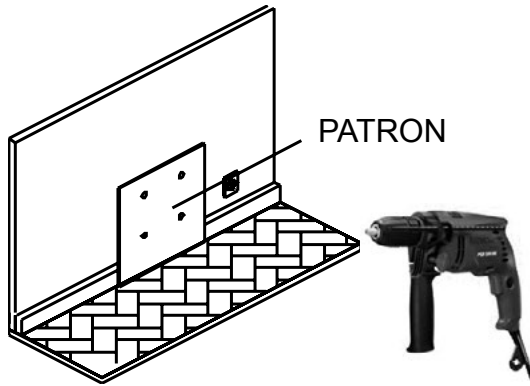

2

Visser
complètement
sans appuyer
(M. 6 x 40 mm)

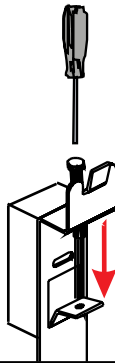

3

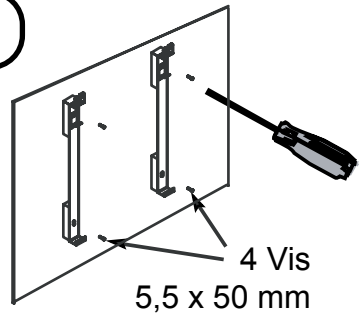

4

Soutenir
le radiateur

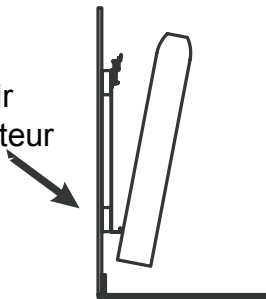

5

1. Déplacer
2. Laisser
tomber
doucement
3. Soutenir

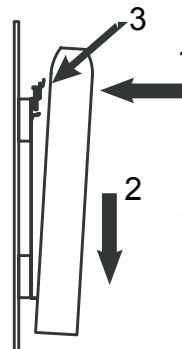

6

**IMPORTANT:**

Visser
complètement pour
ajuster le
radiateur

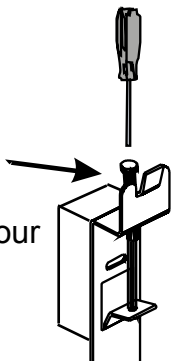

7

Cordon de l'appareil

RÉSEAU 230 V

Bleu ou Gris

Marron

Terre (Vert et jaune)

NEUTRE

PHASE

TERRE

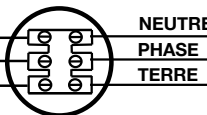

8

L'interrupteur
ON / OFF,
situé dans la
partie posté-
rieure droite
de l'appareil.

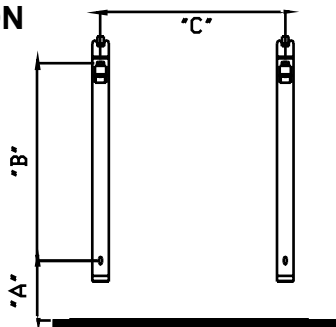
**INFORMATION**

(W)	"A" (mm)	"B" (mm)	"C" (mm)
600	420	246	159
900	420	246	319
1200	420	246	478
1500	420	246	638
1800	420	246	638

3.1 PANNEAU DE COMMANDE

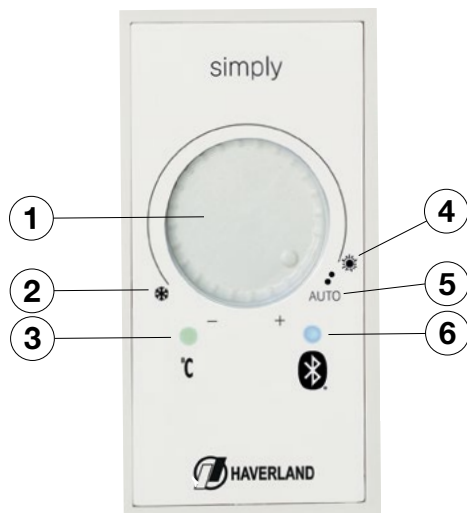

1. Bouton de commande du thermostat
2. Mode Hors-gel
3. Indicateur Led "en fonctionnement"
4. Mode Confort
5. Mode AUTO "Bluetooth®"
6. Indicateur Led "Bluetooth®"

3.2 MODE MANUEL

* Appuyez sur l'interrupteur ON/OFF situé sur le latéral droit. L'appareil est pourvu d'un thermostat réglable qui contrôle la température.

* Indicateur Led "en fonctionnement" s'allumera en indiquant que le radiateur est en marche.

* Pour choisir la température ambiante souhaitée, faites virer le bouton de commande du thermostat électronique sur la position souhaitée.

Le thermostat électronique maintiendra la température constante.

* Le thermostat est pourvu de la position hors-gel. Avec le bouton de commande du thermostat sur la position minimum, l'appareil se mettra en marche quand la température ambiante sera inférieure à 5°C.

NOTE 1



Indicateur Led "en fonctionnement" change lorsque la température de consigne est modifiée ou varie, pour indiquer à l'utilisateur la plage de température sélectionnée et s'affiche en :

- **Rouge** si la température est supérieure à 24°C
- **Jaune** si elle est comprise entre 19°C et 24°C
- **Vert** si elle est inférieure ou égale à 19°C
- **Bleu** si elle est inférieure ou égale à 5°C

3.4 MODE AUTOMATIQUE "BLUETOOTH®"

Haverland a développé une application simple et fonctionnelle vous permettant de créer un programme hebdomadaire, jour par jour.

Téléchargez l'application "Haverland BT" sur votre smartphone et / ou tablette depuis AppleStore (iOS) ou Google Play (Android).



NOTE 2



Assurez-vous que l'application téléchargée est bien celle indiquée.

1



HAVERLAND BT

2

Écran d'accueil

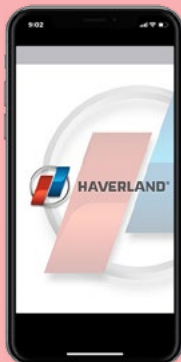

3

Écran programmation

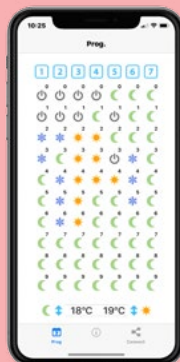

4

Choisissez les températures en mode confort et économie.



5

En appuyant successivement sur les symboles, vous pouvez choisir le mode de fonctionnement souhaité pour chaque heure et chaque jour.



NOTE 3



Pour faciliter la programmation, vous pouvez copier le programme créé pour un jour sur les jours suivants que vous souhaitez.

Appuyez sur le jour à copier (par exemple, lundi "1").

Cliquez sur les jours à copier (par exemple mardi, mercredi et jeudi).

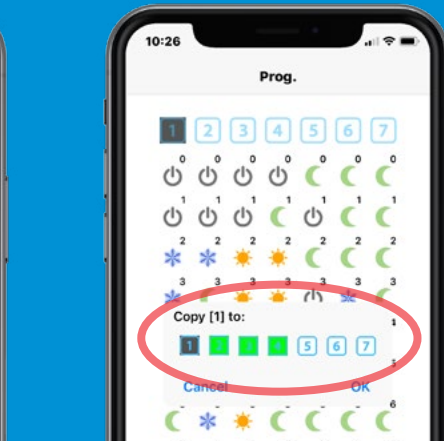

6

Appuyez sur la touche "Connect" pour accéder à l'écran "Connexion".



7

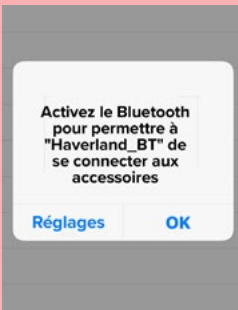

Activez votre connexion BT.

8

Virer le bouton de commande du thermostat électronique sur la position AUTO. Le LED "Bluetooth" clignote.



IMPORTANT:

Si la LED "Bluetooth" est clignote pas, alors virer le bouton dans le sens antihoraire et revirer à AUTO.

9

APPUYER

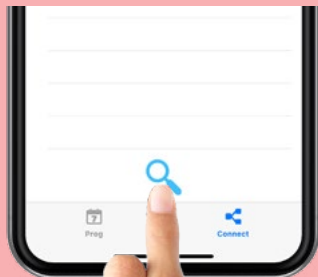

10

Ensuite, l'appareil s'affichera sur votre smartphone. Appuyez sur l'indicatif "HAVERLAND". Un rectangle gris s'affichera.

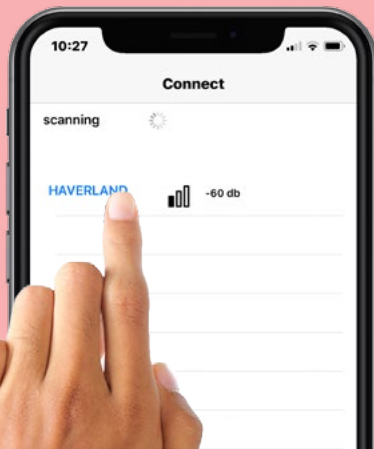

11

Le radiateur est relié votre smartphone ou tablette.

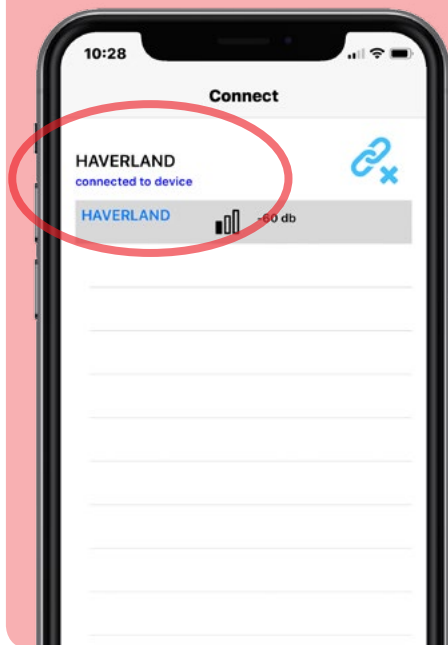

12

Pour finir, "envoyez" le programme configuré à votre radiateur en appuyant sur :

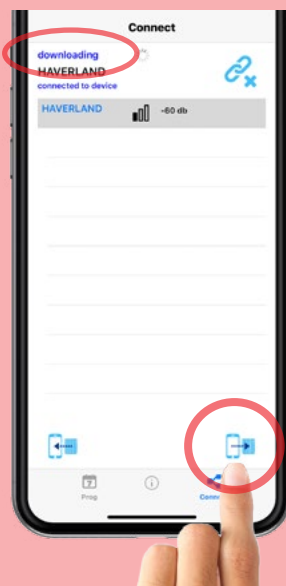
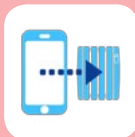

NOTE 4



Pour **déconnecter** le radiateur de votre smartphone ou tablette, pour configurer un autre radiateur, appuyez sur :

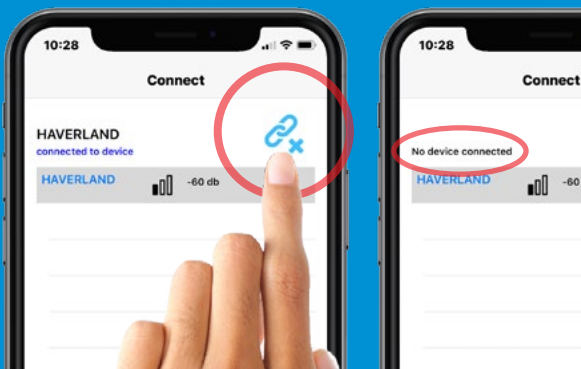

NOTE 5



Une fois le programme envoyé à l'appareil, **le radiateur passera en mode automatique**, quel que soit le mode de fonctionnement en cours, y compris le mode " Hors-gel ".



Indicateur Led "Bluetooth®" indiquent que le radiateur est en **Mode AUTOMATIQUE** et qu'il est connecté à votre smartphone.

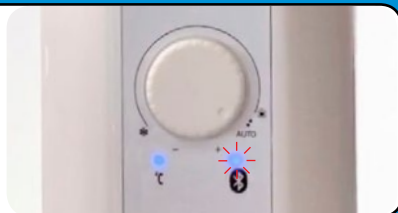

NOTE 6



Si vous ne vous souvenez pas du programme configuré sur votre radiateur, vous pouvez le "récupérer" et le voir à l'écran PROGRAMMATION en appuyant sur :

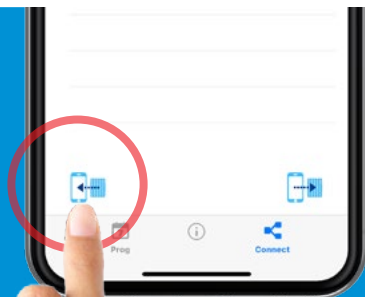

NOTE 7



N'oubliez pas que pour relier votre appareil mobile à votre radiateur, vous devez :

Appuyer sur



et virer le bouton de commande du thermostat sur la position AUTO.

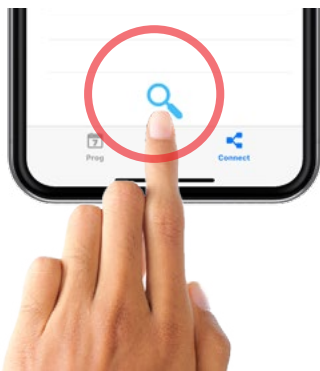

3.5 DÉCONNEXION DU RÉSEAU ÉLECTRIQUE / COUPURE DE COURANT

Si le radiateur est déconnecté du réseau électrique ou en cas de coupure de courant supérieure à 2 heures, **VOUS DEVEZ METTRE À JOUR L'HEURE ET LE JOUR DE LA SEMAINE.**

Les autres paramètres programmés (températures et programmation) sont conservés en mémoire.

POUR METTRE À JOUR L'HEURE ET LE JOUR DE LA SEMAINE :

Si vous avez téléchargé l'application "Haverland BT", reliez votre appareil mobile à votre radiateur (suivez le point 6 précédent) et cliquez sur



l'application

L'heure sera mise à jour via Internet.



3.5 FONCTION INTELLIGENTE ITCS

Le radiateur intègre un **système innovant de contrôle intelligent de la température ITCS**.

Ce système active la mise en marche de l'appareil **avant l'heure programmée** (2 heures maximum), afin de s'assurer que la température souhaitée est atteinte à l'heure indiquée et selon la programmation hebdomadaire établie.

NOTE 8



Cette fonction n'est disponible qu'en mode AUTO.

3.6 FONCTION ÉCONOMIE “ FENÊTRES OUVERTES ”

Cette fonction est activée en cas de chute brutale de la température dans la pièce.

NOTE 9



Lorsque cette fonction est activée, le indicateur Led “en fonctionnement” s'affiche à bleu (mode anti-frost).

L'appareil s'éteindra pour éviter une consommation inutile d'énergie.

Lors de la fermeture de la fenêtre, le radiateur détectera une augmentation de la température ou virer le bouton de commande du thermostat électronique vers la gauche et virer à nouveau le bouton du thermostat sur la position AUTO et cette fonction sera désactivée.

L'appareil se rallumera pour revenir à l'état précédent à la déconnexion.

NOTE 10



Cette fonction n'est disponible qu'en mode AUTO.

4. ENTRETIEN

Votre appareil ne nécessite aucun entretien particulier.

Nettoyez uniquement la poussière qui peut s'accumuler avec un chiffon sec et doux.

Il est recommandé, au début de la saison hivernale, de nettoyer la poussière accumulée sur la surface du radiateur.



NE JAMAIS UTILISER DE SOLVANTS OU DE PRODUITS ABRASIFS.

- **Leia as instruções de montagem.**
- Para desligar o emissor térmico da rede elétrica, retire a ficha de alimentação da tomada. **Nunca puxe o cabo.**
- Não deixe o cabo de ligação em contacto com o aparelho enquanto este estiver aceso.
- **A garantia do aparelho não cobre o não cumprimento das instruções.**



PERIGO: Não tape o aparelho. Não o use para secar roupa. Se o cobrir, corre o risco de um sobreaquecimento.



• **PERIGO: Se o cabo de alimentação estiver danificado, deve ser substituído pelo fabricante ou pelo serviço pós-venda.**



• **PERIGO: Num quarto de banho, o aparelho deve ser instalado de forma a não poder tocado por qualquer pessoa que se encontre na banheira ou duche.**



• **A instalação deve ser realizada levando em consideração estas instruções e de acordo com a legislação elétrica vigente.**

• Durante o funcionamento deve ter-se em atenção manter o aparelho afastado das matérias inflamáveis, tais como, cortinas, tapetes, móveis, etc.

• Verifique se o emissor está desligado antes de realizar qualquer operação no seu interior.

• Este aparelho deve ser ligado á terra.

• **O emissor deve ser instalado de tal maneira que a ficha de ligação esteja sempre acessível. Este emissor não se deve encastrar. Deve-se respeitar sempre as distâncias de segurança.**

• Este aparelho não foi concebido para utilização por pessoas (incluindo crianças) com capacidades físicas, sensoriais ou mentais diminuídas nem com experiência ou conhecimento reduzido, exceto sob supervisão de um responsável pela sua segurança com as instruções de utilização do aparelho. As crianças devem ser vigiadas para garantir que não brincam com o aparelho.

- As crianças com menos de 3 anos devem ser mantidas fora do alcance do aparelho, caso contrario devem estar supervisadas permanente.
- As crianças com mais de 3 e menos de 8 anos devem só podem ligar/desligar o aparelho (on/off), se este estiver colocado ou instalado na posição de funcionamento definitiva, se estiverem supervisadas ou tenham recebido instruções de como usar o aparelho de forma segura e entenderam os riscos que o aparelho envolve.
- As crianças com mais de 3 anos e menos de 8 anos não devem ligar o aparelho na tomada de rede electrica, regular, limpar o aparelho ou realizar operações de manutenção.
- Este aparelho pode ser utilizado por crianças maiores de 8 anos e por pessoas com capacidades físicas, sensoriais ou mentais reduzidas, com pouca experiência ou conhecimento, desde que tenham sido devidamente treinados e são supervisionados por um adulto que conheça os riscos envolvidos.
- A limpeza e a manutenção deve efectuada por pessoas adultas não por crianças. As crianças não devem brincar com o aparelho.
- Deve ter-se um especial cuidado quando estão presentes crianças e pessoas com algum tipo de vulnerabilidade ou deficiência.
- **PERIGO: Algumas peças deste produto podem ficar muito quentes e causar queimaduras.** Deve prestar especial atenção na presença de crianças e de pessoas vulneráveis.



- **PERIGO:** Mantenha os sacos e os restantes acessórios incluídos fora do alcance das crianças.



- Evite tocar nas partes exteriores do emissor durante o funcionamento.
- É normal que na primeira colocação em funcionamento o aparelho liberte um cheiro “a novo”. Deixe o emissor funcionar num local ventilado durante duas ou três horas.
- O emissor **NÃO pode funcionar** com centrais externas de control.
- Antes de cada inverno ou depois de vários dias de inatividade, limpe o aparelho antes de o ligar (siga os passos da secção 4 - Manutenção). Com esta limpeza evitará queimar o pó acumulado e outros resíduos.
- Durante o funcionamento do emissor a convecção emitida junto com

outros fatores ambientais podem descolorar as superfícies metálicas.

- Mudanças bruscas de temperatura ambiente podem provocar “estalidos” e/ou ruidos no emisor. Isto não é indicativo de avaria no emisor.
- Deve ter em conta os requisitos estabelecidos pela legislação para o tratamento e reciclagem de resíduos quando deite o aparelho fora.

**IMPORTANTE**

- É indispensável que o emissor **SEJA FIXADO FIRMEMENTE A UMA PAREDE FIXA E NIVELADA.**
- Verifique se há alguma tomada perto de onde o vai colocar.
- Tire de dentro de caixa o escantilhão onde se indica a posição exacta dos furos.
- Para evitar problemas é necessária uma distância mínima de 15 cm entre o emissor e qualquer.

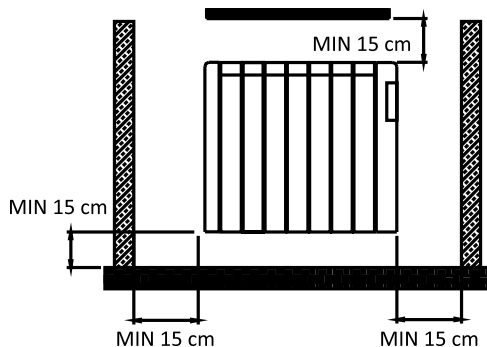

1

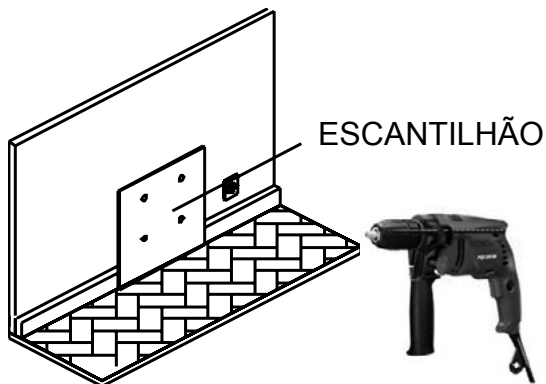

2

APONTE O
PARAFUSO ATÉ QUE
TOQUE NA PATILHA
INFERIOR
(M. 6 x 40 mm)

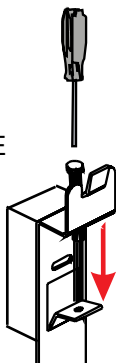

3

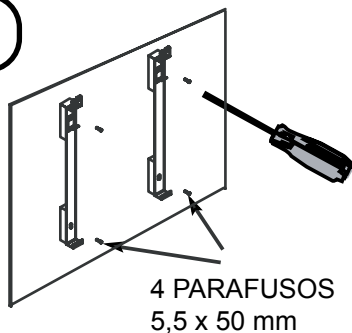

4

APOIE O
EMISSOR

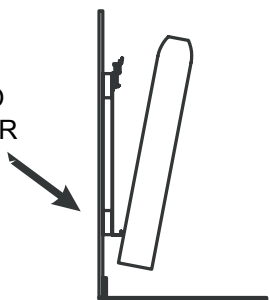

5

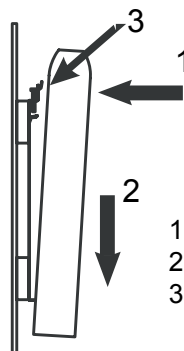

1. DESLOQUE
2. CAIR
3. APOIE

6

**IMPORTANTE:**

TERMINE DE
APARAFUSAR
PARA FIXAR
O EMISSOR

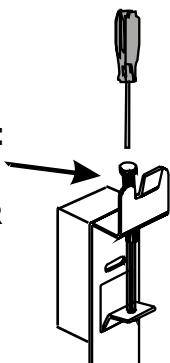

7

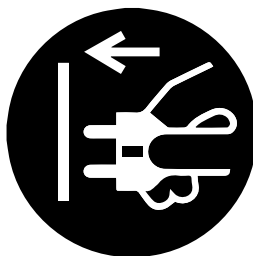

8

Carregue no interruptor ON/
OFF, que se encontra na
parte posterior
direita do apa-
relho.

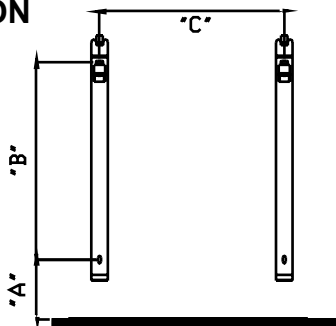
**INFORMACIÓN**

(W)	"A" (mm)	"B" (mm)	"C" (mm)
600	420	246	159
900	420	246	319
1200	420	246	478
1500	420	246	638
1800	420	246	638

3.1 PAINEL DE CONTROLO

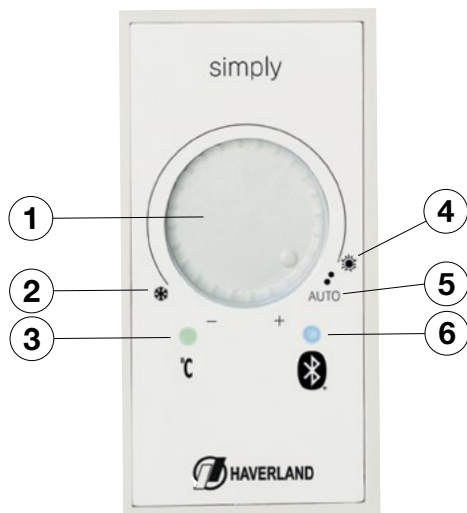

1. Comando do termostato electrónico
2. Modo Anti-gelo
3. Piloto luminoso “Temperatura”
4. Modo Conforto
5. Modo AUTO “Bluetooth®”
6. Piloto luminoso “Bluetooth®”

3.2 MODO MANUAL

* Clique no interruptor ON/OFF situado no lado direito. O aparelho tem incorporado um termostato regulável que controla a temperatura.

* Acende-se um piloto luminoso indicando que o radiador está funcionando.

* Para determinar a temperatura ambiente desejada, vire o comando do termostato electrónico para a posição desejada.

O termostato electrónico irá manter constante a temperatura.

* O termostato está dotado de posição anti-gelo. Com o comando do termostato na posição mínima o aparelho entra em funcionamento quando a temperatura ambiente desce dos 5 °C.

NOTA 1



A cor de piloto luminoso “Temperatura” muda quando as definições de temperatura são alteradas, indicando ao utilizador o intervalo de temperatura selecionado e mostrado a:

- **Vermelho** se a temperatura for superior a 24°C
- **Amarelo** se situar entre 19°C e 24°C
- **Verde** se for igual ou inferior a 19°C
- **Azul** se for igual ou inferior a 5°C

3.4 MODO AUTO “BLUETOOTH®”

A Haverland desenvolveu uma App simples e funcional para que possa criar um programa semanal, diário, hora a hora.

Descarregue a aplicação “**Haverland BT**” para o seu smartphone e/ou tablet na AppleStore (iOS) ou no Google Play (Android).



NOTA2



Certifique-se de que descarrega a app adequada.

1



HAVERLAND BT

2

Visor início



3

Visor programação

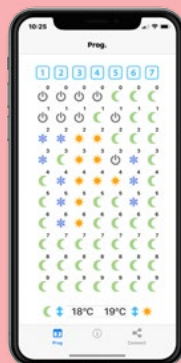

4

Selecione as temperaturas conforto e economia.



5

Pulsando sucessivamente os símbolos seleccione o modo de funcionamento desejado para cada hora e dia.



NOTA 3



Para facilitar a programação, pode copiar o programa criado num determinado dia, para os dias seguintes.

Pulsar no dia a copiar, por exemplo, segunda-feira.

Pulsa nos dias a copiar (por exemplo, terça, quarta e quinta-feira).

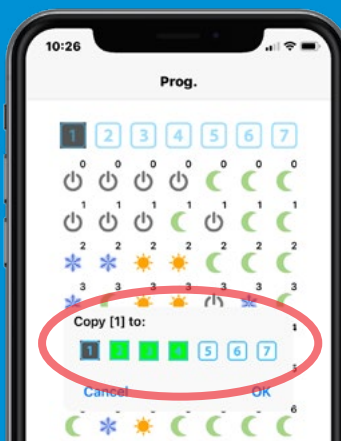

6

Pulse a tecla “Connect” para passar para o visor “conexão”.

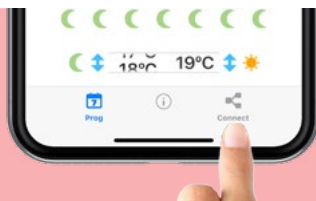

7

Ativa o Bluetooth para permitir que a app “Haverland_BT” se conecte aos acessórios

Ajustes OK

Ative sua conexão BT.

8

Vire o comando do termostato electrónico para a posição AUTO. O piloto “Bluetooth®” irá piscar.

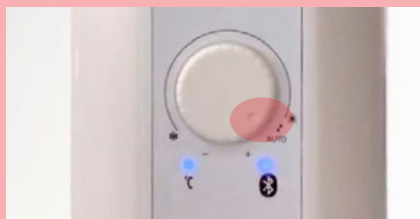

IMPORTANTE:

Se piloto “Bluetooth®” não piscar, gire o botão no sentido anti-horário e retorne para AUTO.

9

Pulsar

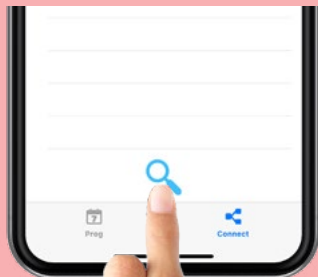

10

Em seguida é mostrado o equipamento no seu smartphone. Pulse em "HAVERLAND". Aparece um retângulo cinza.

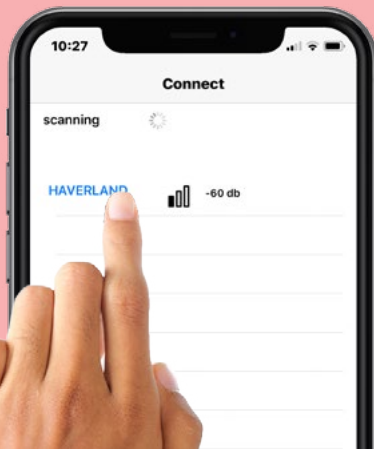

11

O radiador está ligado ao seu smartphone ou tablet.

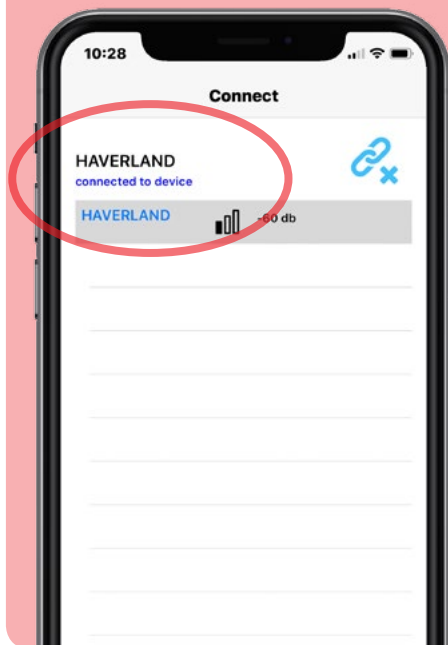

12

Para finalizar, "envie" o programa configurado no seu radiador, pulsando:

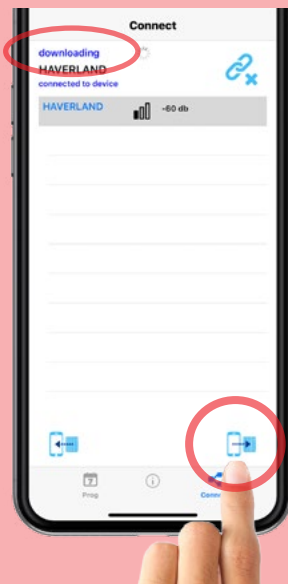
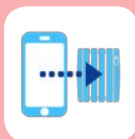

NOTA 4



Para **desligar o radiador do seu smartphone ou tablet**, para configurar outro radiador, pressione:

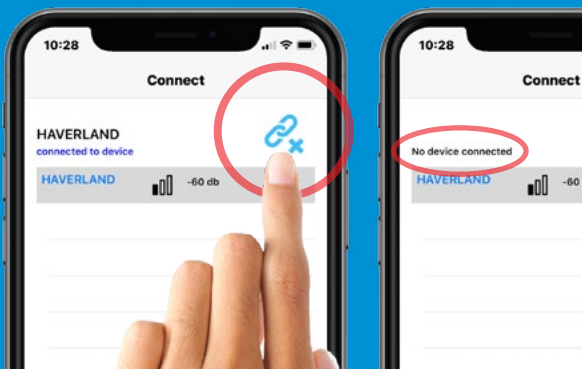

NOTA 5



Depois de o programa ser enviado para o equipamento, **o radiador passa para o modo automático**, independentemente do modo de funcionamento em curso, incluindo o modo “anti-gelo”.



O Piloto luminoso “Bluetooth®” indicam que o radiador está em **modo AUTOMÁTICO e ligado ao seu smartphone**.



NOTA 6



Se não se lembrar do programa configurado no seu radiador, pode “recuperá-lo” e vê-lo no visor **PROGRAMAÇÃO**, pulse

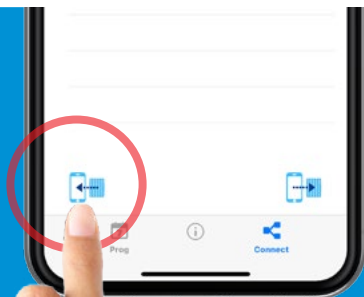

NOTA 7



Lembre-se de que para ligar o seu equipamento móvel ao seu radiador deve

Pulsar



e vire o comando do termostato electrónico para a posição AUTO.

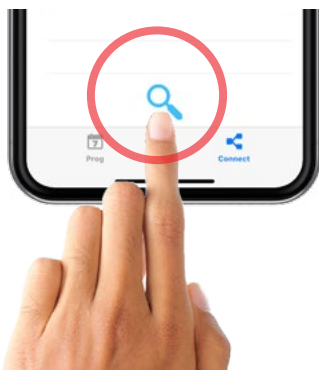

3.5 DESLIGAR REDE ELÉTRICA / CORTE ABASTECIMENTO

Se o radiador estiver desligado da fonte de alimentação ou se verificar um corte no fornecimento de energia **superior a 2 horas, DEVE ACERTAR O RELÓGIO E O DIA DA SEMANA.**

A memória mantém o resto dos parâmetros programados (temperaturas e programação).

ACERTAR O RELÓGIO E O DIA DA SEMANA:

Se tiver descarregado a App **“Haverland BT”**, ligue PT o seu equipamento móvel ao seu radiador (**siga o ponto 6 anterior**) e prima na App .

O relógio é atualizado via internet.



3.5 FUNÇÃO INTELIGENTE ITCS

O radiador inclui um **inovador sistema de controlo inteligente da temperatura ITCS**. Este sistema ativa o arranque do aparelho **antecipadamente à hora programada** (2 horas máximo), para garantir que obtém a temperatura desejada à hora indicada e seguindo o programa semanal estabelecido.

NOTA 8



Esta função está disponível apenas no modo AUTO.

3.6 FUNÇÃO ECONOMIA “JANELAS ABERTAS”

Esta função é ativada quando há uma queda brusca na temperatura na divisão da casa.

NOTA 9



Quando esta função está ativada, aparece o piloto luminoso “Temperatura” no azul (modo antigelo). O equipamento desliga-se evitando um consumo desnecessário de energia.

Ao fechar a janela, o radiador deteta uma subida da temperatura ou vire o comando do termostato electrónico para a esquerda e vire o comando do termostato novamente para a posição AUTO e esta função é desativada.

O equipamento liga-se novamente regressando ao estado antes de ter sido desligado.

NOTA 10



Esta função está disponível apenas no modo AUTO.

4. MANUTENÇÃO

O seu equipamento não requer qualquer manutenção especial.

Limpe apenas o pó que pode acumular-se usando um pano seco e macio.

É conveniente ao iniciar a temporada de inverno, limpar o pó acumulado na superfície do radiador.



NUNCA UTILIZE SOLVENTES OU PRODUTOS ABRASIVOS.

GARANTÍA

MARSAN INDUSTRIAL, S.A. garantiza la conformidad de los aparatos con las especificaciones del contrato.

Esta garantía cubre la reparación del aparato y comprenderá los gastos necesarios realizados para subsanar la falta de conformidad de los bienes con el contrato.

Dicha subsanación será garantizada durante un plazo de 24 meses desde la fecha de compra conforme a la factura contra cualquier defecto de fabricación y funcionamiento durante el uso normal y doméstico de este producto.

El coste del material (piezas y recambios) será garantizado durante un plazo de 36 meses y por 10 años la estanqueidad del cuerpo de aluminio desde la fecha de compra conforme a la factura.

Esta garantía ampara únicamente el aparato cuyo modelo esté anotado en la factura de compra.

Esta garantía NO CUBRE la instalación inadecuada, el mantenimiento, limpieza o conservación del aparato, así como tampoco las averías motivadas por fuerza mayor, agentes químicos o fenómenos atmosféricos, por uso indebido del aparato, por una instalación eléctrica del comprador defectuosa, transporte del aparato, ni por la manipulación del aparato por personal no autorizado por MARSAN INDUSTRIAL, S.A.

Esta garantía no debe ser modificada, alterada ni extendida, y el Fabricante NO autoriza a nadie a actuar en su nombre en la modificación, alteración o extensión de ésta.

Esta garantía se aplica al Producto solamente.

Para la reparación del aparato, el consumidor deberá dirigirse al Servicio de Asistencia Técnica al teléfono 91 324 40 60 (Horario: Lunes a Viernes de 9 a 20 h) o enviar un correo electrónico a postventa@haverland.com solicitando la información necesaria sobre el procedimiento a seguir.

Para la sustitución, cancelación o rebaja del precio, en su caso, el consumidor deberá dirigirse al establecimiento vendedor. Esta garantía no afecta a los derechos de que dispone el consumidor conforme a las previsiones dispuestas en la Ley 23/2003, de Garantía en la Venta de Bienes de Consumo.



Teléfono Atención al Cliente:
91 324 40 60 (L-V: 9 - 20 h)



E-mail: postventa@haverland.com



La presencia de este símbolo sobre alguno de nuestros productos eléctricos o embalajes de presentación, significa que tales productos no deben tratarse como residuos domésticos convencionales en Europa. Para garantizar el tratamiento adecuado de este tipo de residuos, deshágase de los mismos conforme a las leyes pertinentes o según los requisitos de desecho de equipamiento eléctricos. Al tomar esta iniciativa, estará ayudando a preservar el medio ambiente.

Marsan Industrial, S.A.
Avda. San Martín de Valdeiglesias, Km. 2,2
28925 Alcorcón (Madrid)
España

Fabricado en España

Marsan Industrial, S.A. se reserva el derecho a realizar modificaciones sin previo aviso

GUARANTEE

MARSAN INDUSTRIAL, S.A. guarantees that the devices comply with the contracted specifications.

This warranty only covers the model of heater showed on the valid invoice.

Such rectifications will be guaranteed against any manufacturing and operating defect for the normal and domestic use of this product, for a period of 24 months as from the purchase date shown on the invoice.

HAVERLAND guarantees against material, design or manufacturing faults at the moment of its original acquisition for 2 years. The electronic component and paintwork / finish for 3 years and 10 years for the aluminium body (exclude accidental damage, transport, and misuse).

This warranty only covers the device whose model appears on the purchase invoice.

This warranty DOES NOT COVER incorrect installation, maintenance, cleaning or conserving the device, and neither does it cover failures and faults due to force major, chemical agents or atmospheric phenomena, incorrect use of the device, the purchaser's faulty electrical installations, transporting the device or problems caused by the device being handled by persons not authorised by MARSAN INDUSTRIAL, S.A.

This warranty must not be modified, altered or extended, and the Manufacturer does not authorise anybody to act on his behalf to modify, alter or extend it.

This warranty applies only to the Product.

To repair the device, the consumer must dial the Technical Assistance Service at 0330 3651940 or send an email to haverland@haverland.co.uk and ask for the information needed about the procedure to follow:

For a replacement, cancellation or price reduction, when in order, the consumer must go the establishment where the device was purchased. This warranty does not affect the consumers' rights as established in the provisions contained In Law 23/2003, the Consumer Goods Sales Guarantee Act.



Customer Service Telephone:

0330 3651940



E-mail: haverland@haverland.co.uk



Where you see this symbol on any of our electrical products or packaging, it indicates that the relevant electrical product should not be disposed of as general household waste in Europe. To ensure the correct waste treatment of the product, please dispose of it in accordance with any applicable local laws or requirements for disposal of electrical equipment. In so doing, you will help to conserve natural resources and improve standards of environmental protection in treatment and disposal of electrical waste.

Made in Spain

Haverland UK Limited
Challengue House
Sherwood Drive
Bletchley MK3 6DP

Marsan Industrial, S.A. reserves the right to modify without previous warning

GARANTIE

MARSAN INDUSTRIAL, S.A. garantit que les appareils sont conformes aux spécifications du contrat.

Cette garantie couvre la réparation de l'appareil et comprendra les charges nécessaires encourues pour corriger la non-conformité des biens avec le contrat.

Cette correction sera garantie sur une durée de 24 mois après la date d'achat, selon la facture, contre tout défaut de fabrication et de fonctionnement au cours de l'usage normal et domestique de ce produit.

Le coût du matériel (pièces et pièces de rechange) sera garanti pendant une période de 36 mois et l'étanchéité du corps en aluminium, pendant 10 ans après la date d'achat selon la facture.

Cette garantie ne couvre que l'appareil dont le modèle est annoté sur la facture d'achat.

Elle NE COUVRE PAS l'installation incorrecte, l'entretien, le nettoyage ou la conservation de l'appareil, ni les pannes motivées par une cause de force majeure, des agents chimiques ou des phénomènes atmosphériques, par un usage indu de l'appareil, par une installation électrique de l'acheteur défectueuse, par le transport de l'appareil, ni par la manipulation de l'appareil par un personnel non agréé par MARSAN INDUSTRIAL, S.A.

Cette garantie ne doit être ni modifiée ni altérée ni étendue, et le Fabricant n'autorise personne à agir en son nom dans la modification, l'altération ou l'extension de celle-ci.

Cette garantie s'applique uniquement au Produit.

Pour la réparation de l'appareil, le consommateur devra s'adresser au Service d'Assistance Technique en contactant le + 34 91 324 40 60 (Horaire : du lundi au vendredi, de 9 h à 20 h) ou envoyer un email à postventa@haverland.com en sollicitant l'information nécessaire de la démarche à suivre.

Pour demander une substitution, une annulation ou un rabais, le cas échéant, le consommateur devra s'adresser à l'établissement vendeur. Cette garantie n'affecte pas les droits dont dispose le consommateur selon la Loi 23/2003, de Garantie dans la Vente de Biens de Consommation.



Téléphone Service Client:

+ 34 91 324 40 60 (L-V: 9 - 20 h)



E-mail: postventa@haverland.com



Quand vous voyez ce symbole sur l'un de vos produits électriques ou sur l'emballage, ceci veut dire que le produit électrique en question ne doit pas être jeté avec le ordures ménagères ordinaires en Europe. Pour garantir le traitement correct du produit en tant que déchet, veuillez vous en défaire conformément à la législation locale applicable ou aux prescriptions relatives à l'élimination des équipements électriques. De cette façon, vous aiderez à préserver de l'environnement.



Marsan Industrial, S.A.
Avda. San Martín de Valdeiglesias, Km. 2,2
28925 Alcorcón (Madrid)
Espagne

Fabriqué en Espagne

Marsan Industrial, S.A. se réserve le droit de réaliser des modifications sans avis préalable.

GARANTIA

A MARSAN INDUSTRIAL, S.A. garante a conformidade dos aparelhos com as especificações do contrato.

Esta garantia cobre a reparação do aparelho e compreende as despesas necessárias e realizadas para resolver a falta de conformidade dos bens com o contrato.

Esta resolução será garantida durante um prazo de 24 meses desde a data de compra segundo a fatura contra qualquer defeito de fabrico e funcionamento durante uma utilização normal e doméstica deste produto.

O custo do material (peças sobresselentes) será garantido durante um prazo de 36 meses e a estanquidade do corpo de alumínio possui uma garantia de 10 anos a partir da data de compra segundo a factura.

Esta garantia cobre unicamente o aparelho cujo modelo seja indicado na factura de compra.

Esta garantia NÃO COBRE uma instalação inadequada, a manutenção, a limpeza ou conservação do aparelho, as avarias causadas por força maior, agentes químicos ou fenómenos atmosféricos, por utilização indevida do aparelho, por instalação eléctrica do comprador defeituosa, por transporte do aparelho nem pela manipulação do aparelho por pessoal não autorizado pela MARSAN INDUSTRIAL, S. A.

Esta garantia não deve ser modificada, alterada nem ampliada e o Fabricante não autoriza ninguém a agir em seu nome para a modificação, alteração ou ampliação da mesma. Esta garantia aplica-se unicamente ao produto.

Para a reparação do aparelho, o consumidor deve contactar o Serviço de Assistência Técnica através do telefone + 34 91 324 40 60 (Horário: segunda a sexta das 09h00 às 20h00) ou enviar um correio electrónico para postventa@haverland.com, pedindo a informação necessária sobre o procedimento a seguir.

Para a substituição, anulação ou redução do preço, consoante o caso, o consumidor deve contactar o estabelecimento vendedor. Esta garantia não afeita os direitos do consumidor em conformidade com o disposto na Lei 23/2003, sobre a Garantia na Venda de Bens de Consumo.



Apoio ao Cliente:

+ 34 91 324 40 60 (L-V: 9 - 20 h)



E-mail: postventa@haverland.com



Quando encontra este símbolo em qualquer um dos nossos produtos eléctricos ou na respectiva embalagem isso indica que na Europa esse produto eléctrico não deve ser deitado fora juntamente com o lixo doméstico normal. Para assegurar o devido tratamento ecológico deste produto quando o deite fora, é favor acuar em conformidade com as leis ou regulamentos locais aplicáveis para a eliminação de equipamento eléctrico. Se assim o fizer contribui para a protecção ambiental.



Marsan Industrial, S.A.
Avda. San Martín de Valdeiglesias, Km. 2,2
28925 Alcorcón (Madrid)

Espanha

Fabricado em Espanha

Marsan Industrial, S.A. reserva-se o direito de realizar modificações sem aviso prévio

Modelos / Models / <i>Modèles / Modelos</i>	SIMPLY-4	SIMPLY-6	SIMPLY-8	SIMPLY-10	SIMPLY-12
Potencia calorífica / Heat output / <i>Puissance thermique / Potência calorífica</i>					
Potencia calorífica nominal (kW) Nominal heat output (kW) <i>Puissance thermique nominale (kW)</i> <i>Potência calorífica nominal (kW)</i>	0.6	0.9	1.2	1.5	1.8
Potencia calorífica máxima continuada (kW) Maximum continuous heat output (kW) <i>Puissance thermique maximale continue (kW)</i> <i>Potência calorífica continua máxima (kW)</i>	0.6	0.9	1.2	1.5	1.8
Consumo auxiliar de electricidad / Auxiliary electricity consumption / <i>Consommation d'électricité auxiliaire / Consumo de eletricidade auxiliar</i>					
A potencia calorífica nominal (kW) At nominal heat output (kW) <i>À la puissance thermique nominale (kW)</i> <i>À potência calorífica nominal (kW)</i>	0.6	0.9	1.2	1.5	1.8
A potencia calorífica mínima (kW) At minimum heat output (kW) <i>À la puissance thermique minimale (kW)</i> <i>À potência calorífica mínima (kW)</i>	0.6	0.9	1.2	1.5	1.8
En modo de espera (kW) In standby mode (kW) <i>En mode veille (kW)</i> <i>Em estado de vigília (kW)</i>	N.A.	N.A.	N.A.	N.A.	N.A.
Tipo de control de temperatura interior Type of heat room temperature control <i>Type de contrôle de la température de la pièce</i> <i>Tipo de comando da temperatura interior</i>	Con control electrónico de temperatura interior y temporizador semanal Electronic room temperature control plus week timer <i>Contrôle électronique de la température de la pièce et programmeur hebdomadaire</i> <i>Com comando eletrónico da temperatura interior e temporizador semanal</i>				
Otras opciones de control	- Control de temperatura interior con detección de ventanas abiertas - Con control de puesta en marcha adaptable				
Other control options	- Room temperature control, with open window detection - With adaptive start control				
Autres options de contrôle	- <i>Contrôle de la température de la pièce, avec détecteur de fenêtre ouverte</i> - <i>Contrôle adaptatif de l'activation</i>				
Outras opções de comando	- <i>Comando da temperatura interior, com deteção de janelas abertas</i> - <i>Com comando de arranque adaptativo</i>				
Nombre del fabricante / Name del fabricante / <i>Nom du fabricant / Nome do fabricante</i>	Marsan Industrial, S.A.				
Dirección / Address / <i>Adresse / Endereço</i>	Avda. San Martín de Valdeiglesias, Km 2.2 28925 Alcorcón (Madrid) España / Spain / <i>Espagne / Espanha</i>				

SIMPLY



	W	Nº
SIMPLY-4	600	4
SIMPLY-6	900	6
SIMPLY-8	1200	8
SIMPLY-10	1500	10
SIMPLY-12	1800	12

230 V - 50 Hz

CLASE I / CLASS I

CLASSE I