

FAR TOOLS®



GT 600 Professional Machine

- FR** Grignoteuse à tôle (Notice originale)
EN Nibbler (Original manual translation)
DE Nager (Übersetzung aus dem Original-Anleitung)
ES Punzonadora (Traducción del manual de instrucciones originale)
IT Roditrice (Traduzione dell'avvertenza originale)
PT Roedor (Tradução do livro de instruções original)
NL Knabbelschaar (Vertaling van de originele instructies)
EL Ζουμπάς (Τροχος ηατωλές) (Μετάφραση από τις πρωτότυπες οδηγίες)
PL Rozdzierak (Tłumaczenie z oryginalnej instrukcji)
FI Kulmahiomakone (Käännös alkuperäisestä ohjeet)
SV Nibblare (Översättning från originalinstruktioner)
BU Sheet метални ножици (Превод на оригиналната инструкция)
DA Pladeudstanser (Oversættelse fra oprindelige brugsanvisning)
RO Mașină de ștanțat (Traducere din instrucțiunile originale)
RU Высечные ножницы (Перевод с оригинальной инструкции)
TU Tırnaklı sac kesme makinesi (Orijinal talimatlar çeviri)
CS Prostřihovač (Překlad z originálního návodu)
SK Nožnice na plech (Preklad z originálneho návodu)
HE תיורוקמ תוארוהמ סוגרת) מזמרת פח
AR (قي لصرأال تامي لعتلأا نم قم جرتلأا) قين د عملأا حيأ فصرلأا تاصرقمأا
HU Fémlemez olló (Fordítás az eredeti utasítások)
SL Glodač (Prevod iz izvornih navodil)
ET Pleki käärid (Tõlge originaal juhiseid)
LV Izciršanas iekārta (Tulkojumā no instrukcijas oriģinālvalodā)
LT Skardos žirklys (Vertimas iš originalių instrukcijas)
HR Grickalica za lim (Originalne upute)



© FAR GROUP EUROPE

115080-B-20180424

www.fartools.com



FIG. A



FIG. B

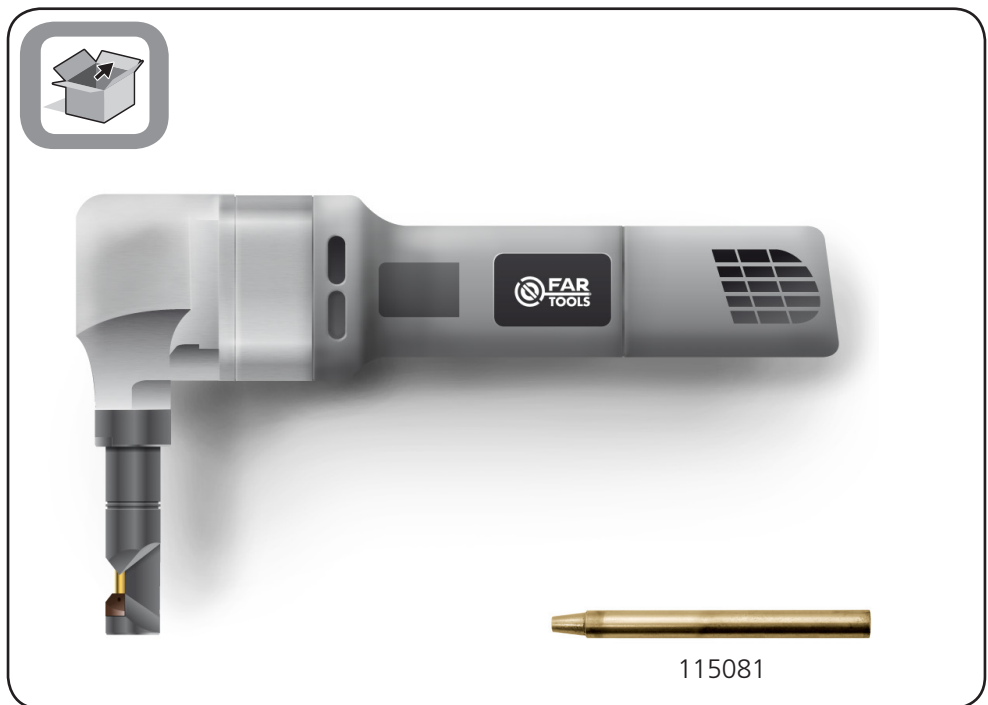



FIG. C

01

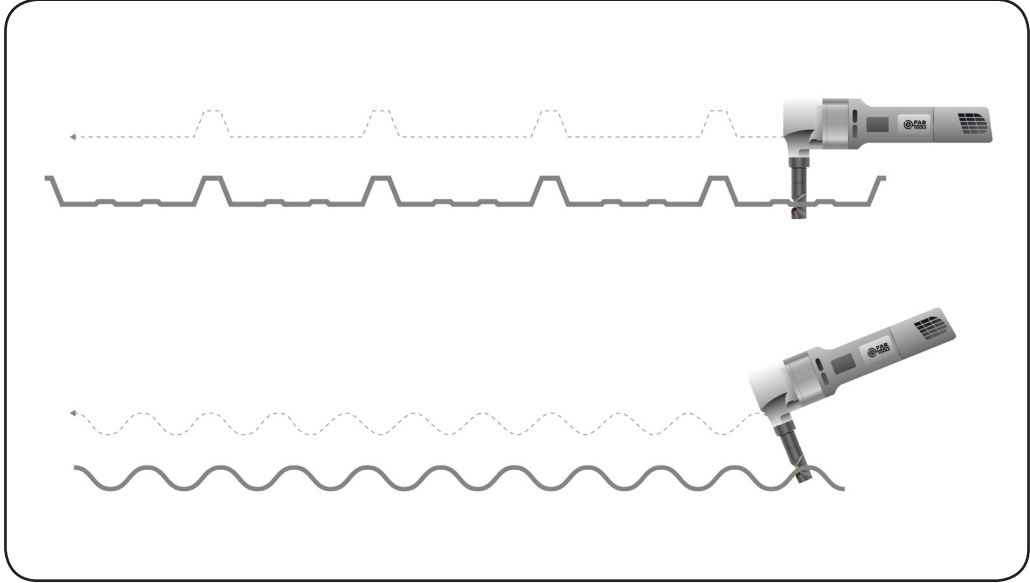
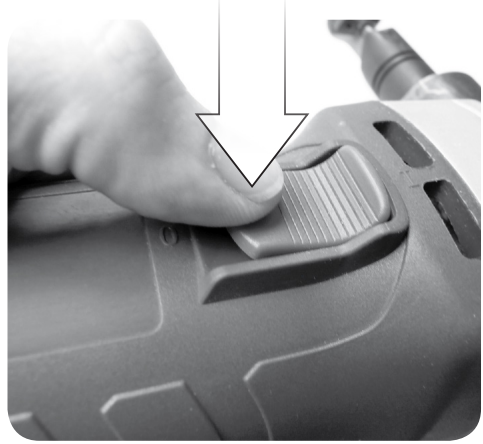
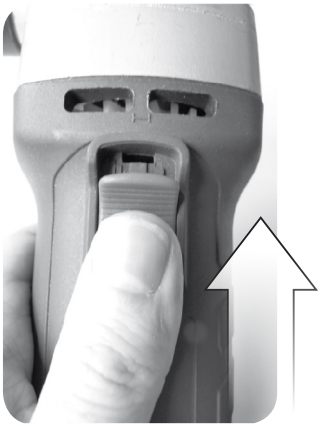



FIG. D

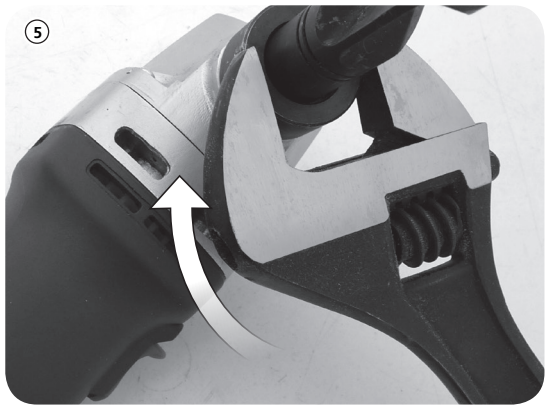
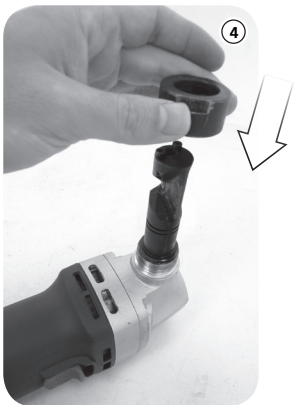
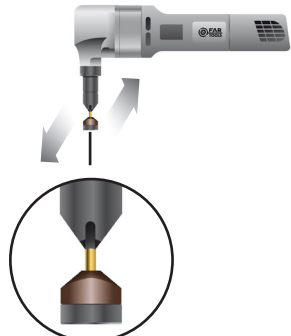
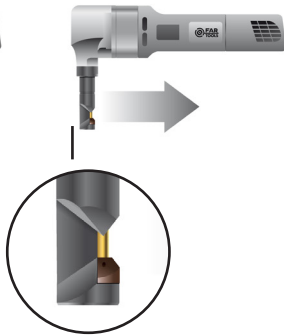
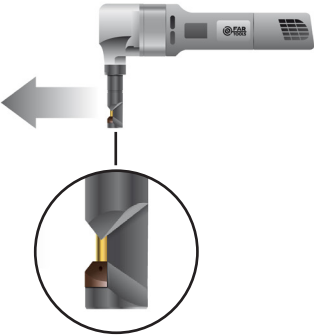
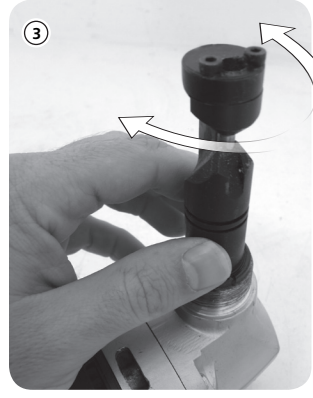
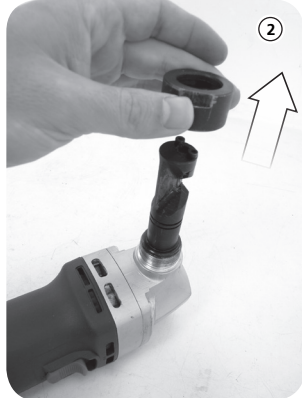
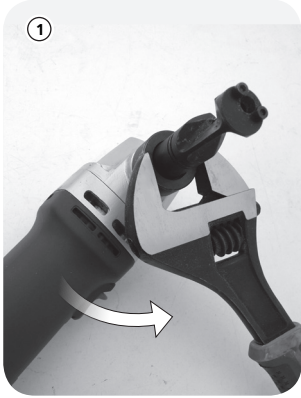



FIG. D

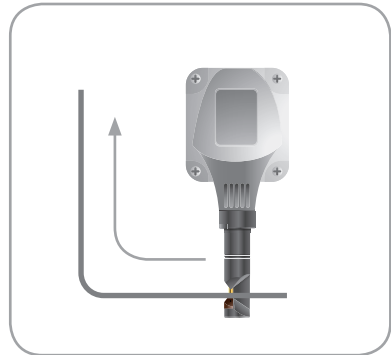
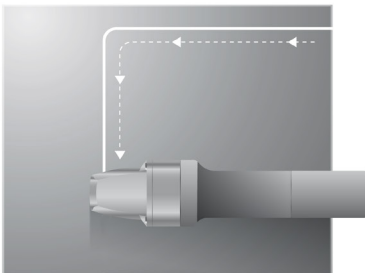
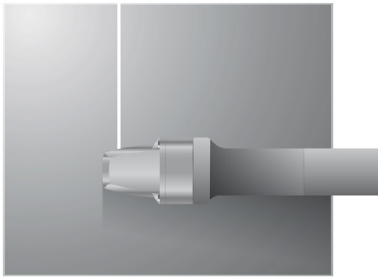
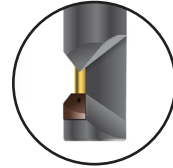
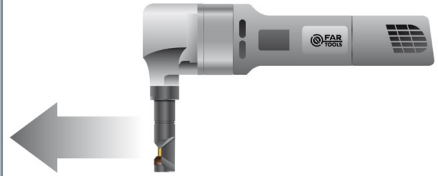
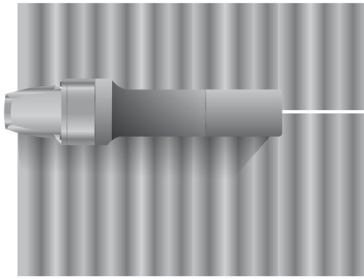
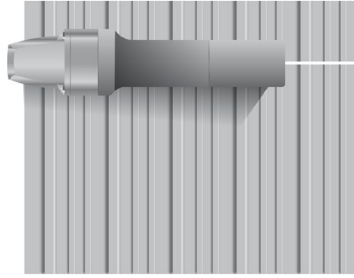



FIG. D

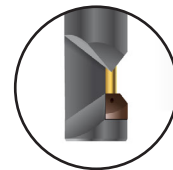
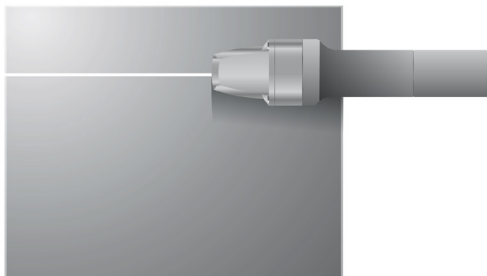
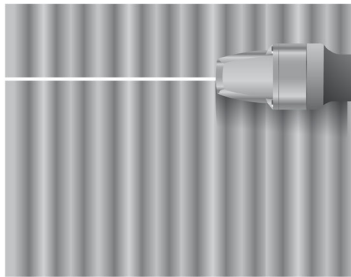
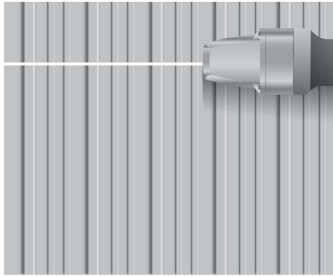
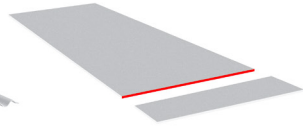
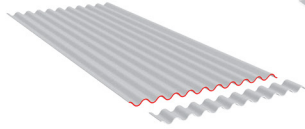
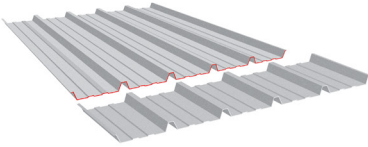
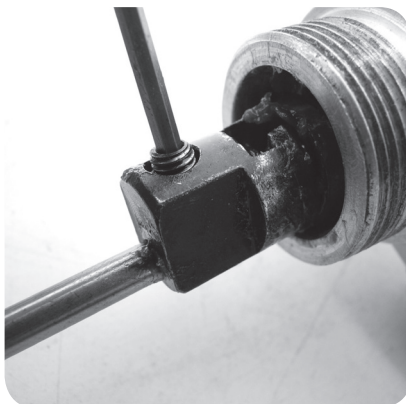
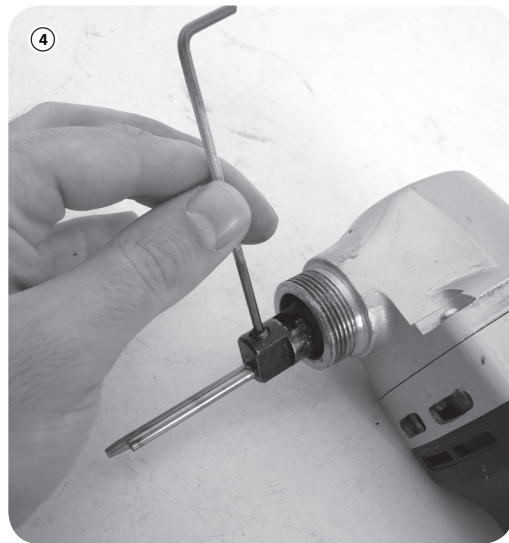
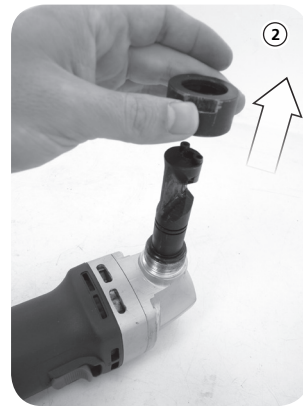
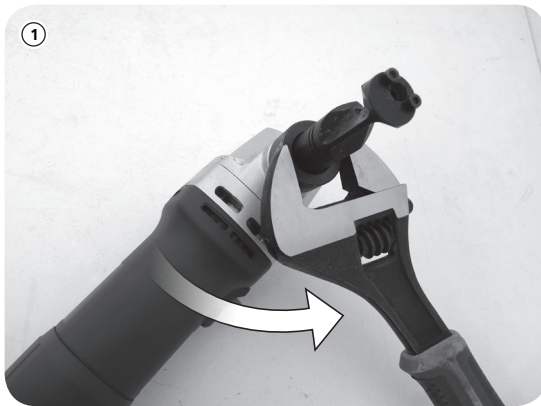
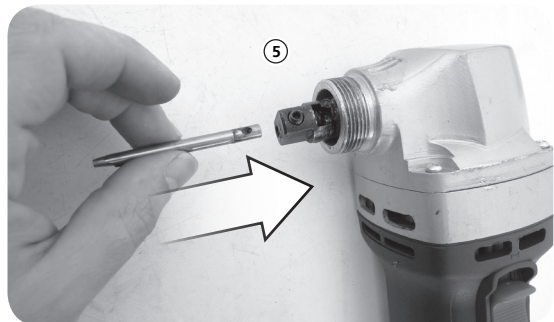





FIG. E





115081





	<p>Tension et fréquence assignée: Nominal frequency and power: Spannung und Frequenz: Tensión y frecuencia fijada: Tensione e frequenza assegnata: Tensão e frequência fixa: Aangewezen spanning en frequentie: Ονομαστική τάση και συχνότητα: Napięcie i częstotliwość przydzielona: Jännite ja määrätty taajuus: Angiven spänning och frekvens: Anført spænding og frekvens: Tensiune și frecvență de lucru:</p>	<p>Заданное напряжение и частота: Tahsis gerilimi ve frekansı: Stanovené napětí a frekvence: Stanovené napätie a frekvencia: מחמת ותדר מוקצב الغسلطية والذبذبية المبرمجة. Névleges feszültség és frekvencia: Napetost in določena frekvenca: Консумирано напрежение и честота : Määratud pinge ja sagedus Nustatyta įtampa ir dažnis Noteiktais spriegums un frekvence. Napon i nazivna frekvencija:</p>	230 V ~ 50 Hz
---	--	---	----------------------

	<p>Puissance assignée: Nominal power: Leerlaufdrehzahl: Potencia fijada: Potenza assegnata: Potência assinada: Onbelast toerental: Ονομαστική ισχύς : Prędkość na biegu jałowym: Teho: Angiven effekt: Anført styrke: Putere de lucru:</p>	<p>Заданная мощность: Tahsis edilen gücü: Stanovený příkon: Predpísaný výkon: כוח מוקצב. القدرة المبرمجة. Névleges teljesítmény : Določena jakost: Консумирана мощност: Määratud võimsus. Nustatyta galia Noteiktā jauda Nazivna snaga:</p>	600 W
---	--	--	--------------

	<p>Vitesse à vide: No-load speed: Drehzahl unbelastet: Velocidad vacía: Velocità a vuoto: Velocidade no vácuo: Leerlaufdrehzahl: Ταχύτητα στο κενό: Prędkość bez bciążenia: Tyhjäkäyntinopeus Tomgångshastighet: Hastighed i ubelastet tilstand: Viteza în gol:</p>	<p>Скорость вращения на холостом ходу: Boşalma hızı: Rychlost naprázdno: Rýchlost pri chode naprázdno: מהירות ריק. السرعة على الفارغ. Üres sebesség: Prosti tek: Скорост на празни обороти: Kiirus tühikäigul Tuščio prietaiso greitis Tukšgaitas ātrums Brzina praznog hoda:</p>	2000 min⁻¹
---	---	--	------------------------------





 L_{pA}	Niveau de pression acoustique : Acoustic pressure level : Schalldruckpegel : Nivel de presión acústica : Livello di pressione acustica : Nivel de pressão acústica : Niveau akoestische druk : Στάθμη Θορύβου : Poziom mocy akustycznej : Käytä kuulosuojaimia: Ljudtryksnivå : Lydtryk : Nivel presiune acustică :	Уровень акустического давления. : Akustik basınç seviyesi : Hladina akustického tlaku : Hladina akustického tlaku : רמת לחץ אקוסטי. مستوى الضغط السمعي. A hangnyomás szintje : Nivo akustičnega pritiska: Равнище на акустично налягане : Helirõhu nivoo Akustinio spaudimo lygis Akustiskā spiediena līmenis Razina zvučnog tlaka:	85 dB (A)
--	---	---	------------------

 L_{wA}	Niveau de puissance acoustique : Acoustic power level : Schallleistungspegel : Nivel de potencia acústica : Livello di potenza acustica: Nivel de potência acústica: Niveau akoestisch vermogen : Στάθμη Ονομαστική Θορύβου : Poziom mocy akustycznej : Käytä suojalaseja : Ljudstyrkenivå : Lydstyrke : Nivel putere acustică :	уровень мощности звука : Akustik basınç seviyesi : Hladina zvukového výkonu: Hladina zvukového výkonu: רמת כוח אקוסטי. مستوى الصوت سمعي ج. a hangnyomás szintje : Nivo akustične jakosti : Равнище на вибрации : Helivõimsuse nivoo Triukšmo lygis Akustiskās jaudas līmenis Razina zvučne snage:	96 dB (A)
--	--	--	------------------

NIVEAU SONORE D'EMISSION:

A VIDE

Pression acoustique LpA poste opérateur
Incertitude

85 dB
3

Puissance acoustique LWA
Incertitude

96 dB
3

Valeurs déterminées suivant le code d'essai de l'annexe B de la norme EN 61029-1 avec emploi des normes de base ISO 11201 et ISO 3744.

Les niveaux de pression acoustique obtenus in situ dépendent:

- Des niveaux réels de la machine considérées, en prenant en compte les incertitudes déclarées;
- Du local et de l'installation de la machine. Préférez une pièce dont l'acoustique est plus feutrée. Evitez les pièces vide à grande résonance. Placez vous auprès d'une fenêtre le cas échéant.
- Des outils montés, des pièces travaillées, des réglages choisis,...

 L_v	Niveau de vibration : Hand/arm vibration level : Vibrationspegel Hand/Arm : Nivel de vibración mano/brazo : Livello di vibrazione mano/braccio : Nivel de vibração mão/braço : Trillingsniveau hand/arm : Στάθμη κρα"οαστών : Poziom wibracji rózka/ramiéz Tärinätaso: Vibrationsnivå hand/arm : Vibrationsniveau : Nivel vibrații :	Уровень вибрации : Titreşim seviyesi : Úroveň vibrací : Hladina vibrácií : רמת תנודות مستوى الارتجاج. Vibrációs szint : Nivo vibracij : Равнище : Vibrācijas līmenis. Vibrācijas lygis Vibratsiooni nivo Razina vibracije:	3,7 m / s²
---	---	---	------------------------------

VIBRATIONS:

Total des valeurs de vibration (somme vectorielle des trois directions) déterminée selon EN 60745:

a 3,7 m/s²
Incertitude K 1,5 m/s²

L'amplitude d'oscillation peut être utilisée comme valeur de comparaison d'outils électroportatifs.

Attention: Si l'outil électroportatif est utilisé pour d'autres applications, avec d'autres outils de travail, l'amplitude d'oscillation peut être différente.





	Conformité européenne Conforms to EC standards : CE-Konformität : Cumple con las directivas CE : Conforme alle norme CE : Conforme às normas CE : Voldoet aan de EG-normen : Συμφώνω με τα πρότυπα Zgodność z normami CE : EU-standardien mukainen : EU-standardien mukainen : Overholder EU standarderne : Conform cu normele europene:	соответствие европейским стандартам: Avrupa uygunluk : evropská shoda : európska dohoda : התאמה לתקנים האירופיים مطابق للمواصفات الأوروبية. evropska ustreznost : európai megfeleléség : Съответствие с европейските норми : Euroopa Liidu vastavusmärk Euroopiņu normų atitikima Atbilstība Eiropas standartiem Evropska skladnost	X

	Lire les instructions avant usage : Read the instructions before use : Vor Einsatz des Geräts Anweisung lesen : Léase las instrucciones antes de usar : Leggere le istruzioni prima dell'uso : Ler as instruções antes da utilização : Lees voor het gebruik de instructies : Διαβάστε τις οδηγίες χρήσης : Zapoznać sięz instrukcją przed użyciem : Lue ohjeet ennen käyttöä : Läs anvisningarna före användning : Læs instruktionerne før brug Înainte de utilizare, citiți instrucțiunile :	Внимательно прочитайте следующие инструкции : Kullanmadan talimatları okuyunuz : Pozorně si přečtěte následující pokyny : Pred použitím si prečítajte pokyny : זרם חילופי اقرأ التعليمات قبل الاستخدام. használat előtt olvassuk el az utasítást : Pred uporabo preberite ustrezna navodila : Прочетете указанията за употреба : Enne kasutamist lugege instruksiooni Prieš naudojimą perskaityti instrukciją izlasīt instrukcijas pirms lietošanas Pročitati upute prije uporabe:	X

	Danger : Danger : Gefahr : Peligro : Pericolo : Perigo : Gevaar : Κίνδυνος : Niebezpieczeństwo : Vaara : Fara : Fare : Pericol :	Опасно : Tehlike : Nebezpečí : Nebezpečenstvo : סכנה. خطر. Veszély : Неварност: Опасночт : Oht Pavojus Bīstamība Opasnost:	X

	Poids : Weight : Gewicht : Peso : Peso : Gewicht : Βάρος : Masa : Paino : Vikt : Vægt : Greutate :	Бec : Ağırlık : Hmotnost : Hmotnost' : משקל العوزن. Súly : Teža : Тегло : Raskus Svoris Svars Težina:	1,83 kg





	<p>Porter des lunettes de sécurité : Porter un masque anti-poussière: Porter une protection auditive: Wear protective eyewear : Wear a dust mask : Wear hearing protective equipment: Schutzbrille tragen : Staubschutzmaske tragen : Gehörschutz tragen: Llevar puestas gafas protectoras : Llevar puesta una careta de protección contra el polvo : Llevar puesta una protección auditiva: Portare de gli occhiali di sicurezza : Indossare una mascherina anti-polvere : Portare una protezione uditiva: Utilizar óculos de segurança : Utilizar uma máscara anti-poeira : Utilizar uma protecção auditiva: Draag een veiligheidsbril : Draag een stofmasker : Draag gehoorbeschermers: Φορέστε Προστατευτικά γυαλιά : χρήση προστατευτικής μάσκα : Φορέστε Προστατευτικά ακουστικά Zakładać okulary ochronne : Zakładać maskę przeciwpyłową Zakładać słuchawki ochronne Käytä suojalaseja : Käytä pölysuojust : Käytä kuulosuojaimia: Använd skyddsglasögon : Bär mask mot damm : Bär hörselskydd: Der skal benyttes sikkerhedsbriller : Der skal benyttes beskyttelsesmaske mod støv: Der skal benyttes hørevern: Purtați ochelari de protecție : Purtați mască anti-praf : Purtați căști de protecție auz:</p>	<p>Наденьте защитные очки : Наденьте респиратор : наденьте средства звуковой защиты: Güvenlik gözlükleri takın : Toza karşı maske takın : İşitsel koruma aleti takın: Požívajte bezpečnostní brýle : Používejte masku proti prachu : Používejte ochranu sluchu: Noste ochranné okuliare : Noste ochrannú masku proti prachu : Noste ochranné slúchadlá: תוחיטב יפקשמ ביכרהל אנ קבא דגנ הכסמ שובחל אנ יש ל הרכיב הגנת שמיעה حَمَل نظارات وقاية. لبس قناع مضاد للغباب. لبس خوذة ضوضاء الخسجي. Viseljen védőszemüveget : Viseljen porvédő maszkot Viseljen fülvédőt Nositi zaščitna očala : Nositi zaščitno masko proti prahu: Nositi zašito ušes: Да се използват защитни очила : Да се използва защитна маска : Да се използва слухови защитни средства: Kandke kaitseprille Kandke tolmumaski. Kandke kõrvakaitset Nešioti apsauginius akinius Dėvėti respiratorių Nešioti apsaugą nuo triukšmo Valkāt aizsargbrilles Valkāt aizsarg masku pret putekļiem valkāt dzirdes aizsarglīdzekli Nositi zaštitne naočale: Nositi masku za zaštitu od prašine: Nositi štitnike protiv buke:</p>	X
---	--	--	---

	<p>Porter des gants : Use rubber gloves : Schutzhandschuhe tragen : Llevar guantes de protección : Indossare i guanti di protezione : Utilizar luvas de protecção : Draag veiligheidshandschoenen : χρήση προστατευτικών γαντιών : Używać rękawic ochronnych : Käytä suojakäsineitä : Använd skyddshandskar : Der skal benyttes handsker : Purtați mănuși :</p>	<p>Наденьте перчатки : Eldiven takın : Noste rukavice : Noste rukavice : תופפכ שובלל אנ لبس قفازات. Viseljen kesztyű t Nositi rokavice: a se използват предпазни ръкавици : Kandke kindaid Müvėti pirštines Valkāt cimduš Nositi zaštitne rukavice:</p>	X
---	---	---	---





	<p>Soumis à recyclage Subjected to recycling Sujeto a reciclaje Sottoposti a riciclaggio Sujeitos à reciclagem Nāo deite no lixo : Niet wegwerpen : Μην την πετάτε : Nie wyrzucas : Älä heitä pois luontoon : Batteriet får inte kastas : Bortkast det ikke: Nu le auncati :</p>	<p>Не выбрасывайте в мусорный ящик Atmayiniz : Nevyhazujte je do bežného odpadu : Neodhadzovat : אין לזרוק סוללות فلا ترمدها بلذا في القمامة. ne mečite! Ne odvržite ga/jih vstran : Не го изхвърляйте : Ärge visake seda minema : Nemétykíte : Nemest : Podvrgnuto recikliranju</p>	X
---	--	--	---

FR-Recyclage des déchets :

Les outils, accessoires et leur emballages doivent suivre une voie de recyclage adaptée. Conformément aux directives Européenne 2012/19/UE et 2006/66/CE, les composants d'un produit doivent être séparés, collectés, recyclés ou éliminés en conformité avec les réglementations environnementales en vigueur. Les appareils, batteries, piles, huiles, emballages devront être déposés dans les systèmes d'élimination des déchets spéciaux tels que déchetteries. Renseignez-vous auprès de votre commune pour connaître l'organisme le plus proche à même de retraiter ou de collecter ces déchets.

NL-Waste recycling:

Gereedschappen, accessoires en de verpakking moet een recycling traject aangepast volgen. Overeenstemming met de Europese Richtlijnen 2012/19/UE en 2006/66/CE, de onderdelen van een product moet worden gescheiden, verzameld, gerecycleerd of verwijderd in overeenstemming met de milieuvorschriften. Apparaten, batterijen, olie, moet de verpakking worden gedeponereerd in de verwijdering van gevaarlijke afvalstoffen, zoals afvalverwerking systemen. Informeer bij uw gemeente naar de dichtstbijzijnde staat om opnieuw te verwerken of te verzamelen het afval lichaam te vinden.

EN-Waste recycling:

The tools, accessories and their packaging must use an appropriate recycling channel. In compliance with European Directives 2012/19/UE and 2006/66/CE, a product's components must be separated, collected, recycled or eliminated in accordance with the environmental regulations in force. The appliance, batteries, oils and packaging must be deposited in the special waste elimination systems such as the waste collection centres. Ask your commune for information on the nearest organisation in a position to reprocess or collect this waste

ES-Reciclado de los residuos:

Las herramientas, los accesorios y los envases tienen que seguir la vía de reciclaje adecuada. En virtud de las directivas europeas 2012/19/UE y 2006/66/CE, los componentes de un producto deben separarse, recogerse, reciclarse o eliminarse de acuerdo con las reglamentaciones medioambientales vigentes. Los aparatos, baterías, pilas, aceites, envases deberán llevarse a los centros de eliminación de residuos especiales tales como los ecoparques. Pedir información al municipio par conocer el centro más cercano apto para reciclar o recoger dichos residuos.

IT-Riciclaggio dei rifiuti:

Gli apparecchi, i loro accessori ed imballaggi devono essere sottoposti ad un processo di riciclaggio appropriato. In conformità con le direttive europee 2012/19/UE e 2006/66/CE, i componenti di un prodotto devono essere separati, raccolti, riciclati o smaltiti in conformità con le normative ambientali in vigore. Gli apparecchi, le batterie, le pile, gli oli, gli imballaggi dovranno essere conferiti nei sistemi di smaltimento dei rifiuti speciali come le isole ecologiche. Informarsi presso il proprio comune per sapere qual è l'ente più vicino in grado di fare il trattamento o la raccolta differenziata di questi rifiuti

PT-Reciclagem do lixo:

As ferramentas, acessórios e suas embalagens devem seguir um canal de reciclagem adaptado. Conformemente às diretivas europeias 2012/19/UE e 2006/66/CE, os componentes de um produto devem ser separados, recolhidos, reciclados ou eliminados de acordo com as regulamentações ambientais em vigor. Os aparelhos, baterias, pilhas, óleos e embalagens deverão ser depositados nos sistemas de eliminação de detritos especiais, tais como unidades de triagem de detritos. Informar-se junto ao seu concelho municipal para conhecer o órgão mais próximo habilitado a evacuar ou recolher estes detritos.

HR-Recikliranje otpada:

Alati, dodatci i njihova ambalaža moraju slijediti odgovaraju i postupak recikliranja. Sukladno Europskim direktivama 2012/19/ EU i 2006/66/EZ, komponente proizvoda moraju se odvajati, skupljati, reciklirati ili odlagati u skladu s važe im propisima o zaštiti okoliša. Ure aji, akumulatori, baterije, ulja i ambalaža moraju se odlagati u posebne sustave za odlaganje otpada, kao što su sakupjalista za otpad. Raspitajte se u nadležnim op inskim tijelima koji je najbliži subjekt koji može tretirati ili sakupiti ovaj otpad.

	<p>Recyclable, soumis au tri sélectif Recyclable, subject to recycling Recyclingfähige, unterliegen Recycling Reciclables, sujetos a reciclaje Riciclabili, soggetti a riciclaggio Recicláveis, sujeito à reciclagem Recycleerbare, onderworpen aan recycling Ανακυκλώσιμες συσκευασίες που υπόκεινται σε κύκλωση Opakowanie nadaje się do recyklingu podlegają recyklingu Kierrätettävien pakkausten kohteena kierrätys Återvinningsbara förpackningar omfattas återvinning Рециклиращи се опаковки подлежат на рециклиране Genanvendelig underlagt genbrug</p>	<p>Reciclabile sub rezerva reciclaré Повторно упаковка подлежат вторичной переработке Geri dönüştürüm Geri dönüştürülebilir ambalaj konusu Recyklovateľné podléhající recyklaci Recyklovateľné podliehajúce recyklácii רוחמל ורוחמל הזיראה אשון رودندلا هاءال يرضخت رودندلا هاءال قلاباول فبوليغتلار توب پتلا Újrahasznosítható csomagolás alá újrahasznosítás Reciklirati predmet recikliranje Pakendite suhtes ringlussevütü Pärsträdajams iepakojuoms otrreizējai pārstrādei Perdirbamų taikomos perdirbimo Može se reciklirati, podložno selektivnom sortiranju</p>	X
---	---	---	---





GT 600

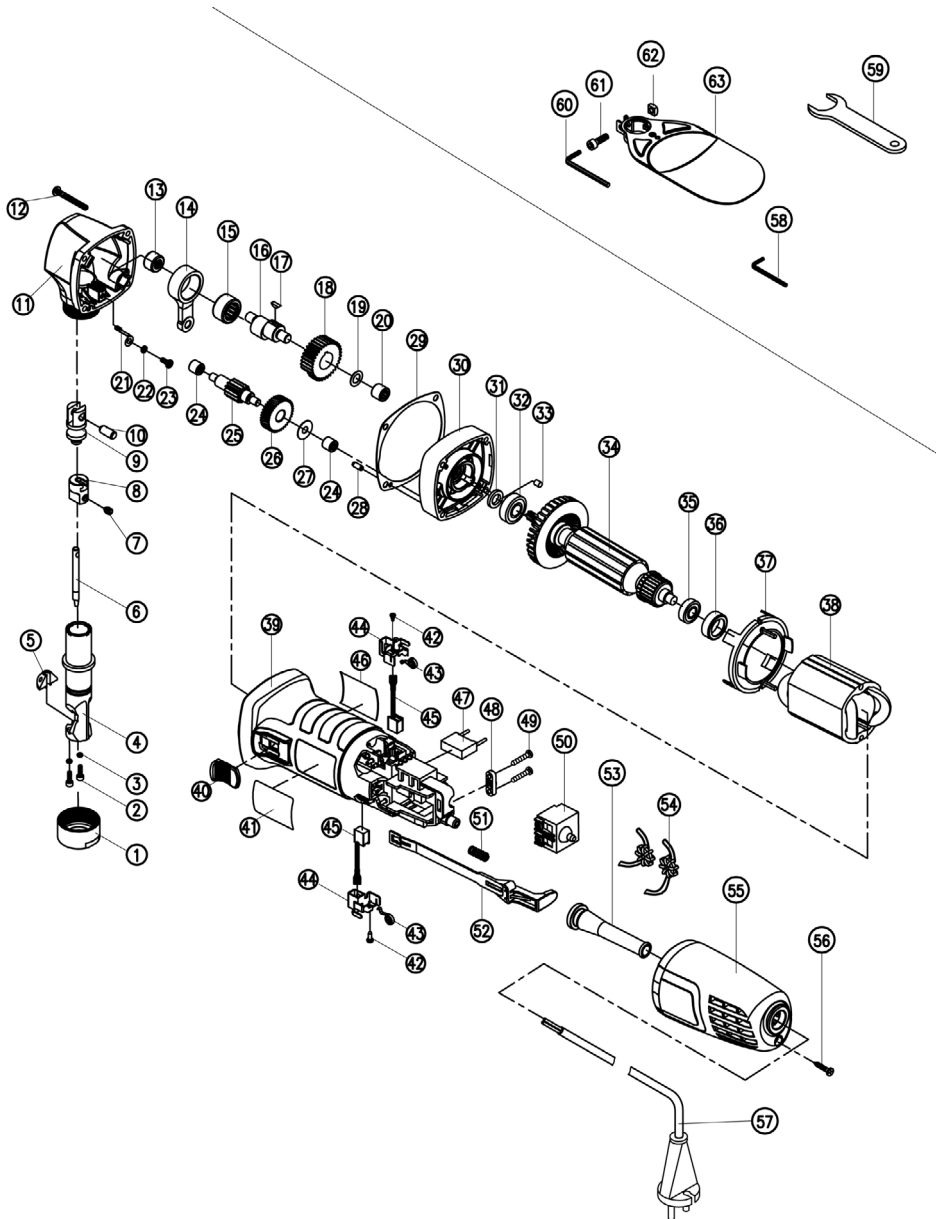





DECLARATION DE CONFORMITE
 VERKLARING VAN OVEREENSTEMMING
 DECLARACION DE CONFORMIDAD
 DICHIARAZIONE DI CONFORMITA
 KONFORMITÄSERKLÄRUNG
 DECLARAÇÃO DE CONFORMIDADE
 DEKLARACJA ZGODNOSCI Z NORMAMI
 OM ÖVERENSSTÄMMELSE
 VAATIMUSTENMUKAISUUSVAKUUTUS
 Overensstemmelseserklæring
 Δήλωση συμμόρφωσης/συμμόρφωσης

Declaratie de conformitate
 Vyhlasenie zhody
 Декларация соответствия
 הצהרת תואמת
 UYGUNLUK BEYANI
 التصريح بالاطابقة
 Prohlášení shody
 Egyezőségi nyilatkozat
 Декларация за съответствие с нормите
 Izjava o skladnosti
 DEKLARACIJA
 ATTIKTIKTES DEKLARACIJA
 KINNITUS

Le soussigné,
 Ondergetekende,
 Der Unterzeichner,
 O abaixo assinado,
 Undertecknad,
 Долуподписаният
 Undertegnede
 Subsemnatul,
 Я, нижеподписавшийся,
 Imzalayan,
 Niže podepsany,
 Toliau pasirašęs

Personne autorisée à constituer
 le dossier technique :
 Christophe HUREL



FAR GROUP EUROPE
 192, Avenue Yves Farge
 37700 Saint-Pierre-des-Corps
 FRANCE

El suscrito,
 Il sottoscritto,
 The undersigned,
 Níneį podpisany
 Allekirjoittanut,
 Ουπτογεγραμμένος
 Nižšie podpisany
 הכתום מטה
 الحق اء اءناه
 Alulírótt,
 Podpisani,
 Apakšā parakstíjies
 allkirjutanu

Declara por la presente que,
 Dichiare che,
 Declares that,
 OÖwiadcza niniejszym, że
 Ilmoittetaan täten että,
 Δηλώνει με την Παρούσα
 týmto vyhlasuje, že
 מצהיר בה כן
 یصريح استنادا على ذلك
 kijelentem, hogy a készülék Izjavlja da,
 Pareiškia, kad
 Ar šo apliecina, ka,
 Kinnitab, et

Déclare par la présente que,
 Verklaart hiermede dat,
 Erklärt hiermit daß,
 Declara pela presente que,
 Förklarar härmed att
 Заявляя с настоящото
 erklærer hermed, at
 Declar prin prezenta că
 настоящим подтверждаю, что
 Mecvut belgeyle beyan ediliyor ki,
 tímto prohlašuje, že,
 Pareiškia, kad,

Grignoteuse à tôle / Nibbler / Nager / Punzonadora / Roditrice / Roedor / Knabberschaar / Ζουμπάξ / Rozdzierak / Kulmahiomakone / Nibblare / Sheet metalni nožnici / Pladeustanser / Maşină de ştanţat / Высечные ножницы / Trnaki sac kesme makinesi / Proštrihovač / Nožnice na plech / מזמרת פח / قیذعہل حی انفسرل حاصرقم / Fémlemez olló / Glodač / Pleki käärid / Izciršanas iekārta / Skardos žirkļs

code

FARTOOLS / 115080 / GT 600 / J1J-HJ9101

Est conforme et satisfait aux directives et normes CE,
 In overeenstemming is met en Voldoet aan EG richtlijnen,
 Den folgenden EU-Bestimmungen entspricht,
 Respeita e está em conformidade com as normas CE,
 Överensstämmer med och uppfyller EG-standarder,
 Съответства и отговаря европейските норми
 er i overensstemmelse med og overholder EU standarderne
 Este conform și satisfacă normele CE
 полностью соответствует и удовлетворяет
 требованиям стандартов ЕС
 CE şartlara uygundur,
 odpovídá normám ES,
 Attitinka ir atitinka EB direktyvas ir standartus,

Cumple con la directivas de la CE,
 E conforme alle direttive CEE,
 Complies with the EEC directives and standards,
 Odpowiada normom UE,
 Täyttää EU-vaatimukset,
 Είναι σύμμορφωτο και ανταποκρίνεται στα Πρωτόλλα CE
 zodpovedá normám ES,
 מתאים ועונה לתקני CE
 بان الهاز يطابق و يلبى م مجموعة الدول الأوروبية
 kielégíti a CE szabványok előírásait.
 Je v skladu z in izpolnjuje norme Evropske skupnosti.
 Atbilst un atbilst EK direktīvas un standartus,
 Vastab ja vastab EU direktīviudei ja standartitei,

2014/30/EU 2006/42/EC 2011/65/EU

EN60745-1:2009+A11:2010
 EN60745-2-8:2009
 EN55014-1:2017
 EN55014-2:2015
 EN61000-3-2:2014
 EN61000-3-3:2013

Christophe HUREL,
 Président Directeur Général
 24/05/2018
 Fait à Saint Pierre des Corps





FR. GARANTIE

Cet outil est garanti contractuellement contre tout vice de construction et de matière, à compter de la date de vente à l'utilisateur et sur simple présentation du ticket de caisse. La garantie consiste à remplacer les parties défectueuses. Cette garantie n'est pas applicable en cas d'exploitation non conforme aux normes de l'appareil, ni en cas de dommages causés par des interventions non autorisées ou par négligence de la part de l'acheteur. La garantie ne s'applique pas sur les dommages causés par une défaillance de l'outil.

DE. GARANTIE

Die Garantiezeit für dieses Gerät in bezug auf Konstruktions- und Materialfehler beträgt lt. Vertrag bei Vorlage des Kassensbons. Die Garantieleistung besteht im Ersatz schadhafter Teile. Die Garantie erlischt bei einem Einsatz des Geräts, der nicht normentsprechend ist, bei Schäden, die auf unsachgemäße Eingriffe zurückzuführen sind bzw. bei Nachlässigkeit seitens des Käufers. Die Garantie erstreckt sich nicht auf Schäden, die auf Fehlfunktionen des Geräts zurückzuführen sind.

IT. GARANZIA

Quest' attrezzo è garantito per contratto contro qualsiasi difetto di costruzione e di materia, a partire dalla data di vendita all' utente e su semplice presentazione dello scontrino. La garanzia consiste nel sostituire le parti difettose. Questa garanzia non è applicabile in caso di sfruttamento non conforme alle norme dell' apparecchio, né in caso di danni causati da interventi non autorizzati o da negligenza da parte dell' acquirente. La garanzia non si applica ai danni causati da un' avaria dell' attrezzo.

EN. GARANTEE

This tool is guaranteed, in writing, against any defect in manufacture or parts from the date of sale, upon simple presentation of the sales slip. The guarantee is limited to the replacement of faulty parts. This guarantee is not applicable in the event of usage which is not conform with the intended usage of the apparatus, nor in the event of damage caused by unauthorised servicing or negligence on behalf of the purchaser. This guarantee does not apply to any damage caused by the failure of this tool.

ES. GARANTIA

Esta herramienta se garantiza contractualmente contra todo defecto de construcción y materia, a partir de la fecha de venta a l' usuario y sobre simple presentación del recibo de caja. La garantía consiste en sustituir a las partes defectuosas. Esta garantía no es aplicable en caso de explotación no conforme a las normas del aparato, ni en caso de daños causados por intervenciones no autorizadas o por negligencia por parte del comprador. La garantía no se aplica sobre los daños causados por un fallo del herramienta.

NL. GARANTIE

Dit gereedschap heeft een garantie tegen constructiefouten en materiaaldefecten, die geldig is vanaf de aankoopdatum door de gebruiker, op vertoning van de kassabon. De garantie betreft de vervanging van de defecte onderdelen. Deze garantie is niet van toepassing indien het apparaat niet volgens de normen gebruikt is, noch in geval van schade veroorzaakt door oneigenlijk gebruik of nalatigheid van de koper. De garantie is niet van toepassing op schade voortvloeiend uit een defect van het gereedschap.

PT. GARANTIA

Esta ferramenta tem uma garantia contratual contra qualquer defeito de construção e de material, a partir da data de venda ao utilizador e sobre simples apresentação do talão da caixa.. A garantia consiste em substituir as partes defeituosas. Esta garantia não é aplicável no caso de exploração não conforme às normas do aparelho, nem em caso de danos causados pelas intervenções não autorizadas ou por negligência da parte do comprador. A garantia não se aplica para os danos causados por uma falha da ferramenta.

EL. Εγγύηση

Το εργαλείο αυτό φέρει συμβατική εγγύηση για οποιούδηποτε έλαττωμα κατασκευής απ'ο την ημερομηνία Πώλησης στο χρήστη. με απλή Προσκόμιση της απ'ο'οειξης αγοράς. Η εγγύηση αποτελείται απ'ο την αντικατάσταση των ελαττωματικών τμημάτων. Η Παρούσα εγγύηση οεν εφαρμόζεται σε περίπτωση χρήσης μη σύμφωνα με τα Πρόσωπα της συσκευής. η σε περίπτωση που Προκληθήκε απ'ο μη εξεικερμ'εινη επ'εμβαση η απ'ο αμ'ελεια του αγοραστή. Η εγγύηση "οεν εφαρμόζεται στις ζημιές που Προκαλούνται απ'ο βλ'αβη του εργαλείου Σταυρού κενού Διαστημο-Παρέμβουμα

PL. GWARANCJA

Narz' dzie jest obj' te gwarancj' na wszelkie wady konstrukcyjne i materia[]owe, licz'ac od daty sprzed' y u' ytkownikowi i po okazaniu paragonu kasowego. Gwarancj' obejmuje wymian' cz' 'ci wybrakowanych. Gwarancj' nie znajduje zastosowania w przypadku u' ytkowania niezgodnego z normami urz'adzenia, ani w przypadku szk'od spowodowanych dzia[]aniami niedozwolonymi lub zaniebaniami ze strony nabywcy. Gwarancj' nie obejmuje szk'od powsta[]ych z powodu upadku urz'adzenia.

SV. GARANTI

Detta verktyg har en avtalsenlig garanti mot konstruktions- och materialfel, fr'ån och med tidpunkten f'or anv'andarens ink'op och genom uppvisning av kassakvittot. Garantin best'år i att ers'atta de bristf'alliga delarna. Denna garanti g'aller inte om anv'andningen inte motsvarar apparatens standarder, inte heller vid skador som orsakas av ej till'atna ingrepp eller p' grund av k'oparens v'ardsl'oshet. Garantin g'aller inte f'orskador som orsakats av att verktyget fungerat bristf'alligt.

FI. TAKUU

T'ämän laitteen takuu on voimassa sopimuskennmukaisesti kattaa kaikki rakenne- ja materiaaliiviat lukien ostop'iv'ast'ä kassakuittia vastaan. Takuu sis'ält'ää viallisten osien korvaamisen. Takuu ei korvaa ohjeidenvastaista k'aytt'oa eik'ä valtuuttamattomien henkil'oiden k'asittelyst'ä tai ostajan huolimattomuudesta aiheutuneita vahinkoja. Takuu ei vastaa my'osk'ään toimintah'airi'ost'ä aiheutuneita vahinkoja.

BU. Гаранция

Този инструмент е под договорна гаранция срещу всякакъв дефект в изработката и използваните материали, считано от датата на продажба на потребителя и само срещу представяне на касовата бележка. Гаранционното обслужване се състои в замяна на дефектните части. Настоящата гаранция не е валидна когато апаратът се използва по начин, несъответстващ на стандарта за работа с него, както и в случай на щети, нанесени от неоторизирани лица, или вследствие на проявена небрежност от страна на потребителя.

Гаранцията не покрива щети, произтекли вследствие на техническа неизправност на апарата.





DA. GARANTI

Dette værktøj er dækket af en garantikontrakt for konstruktions- og materialefejl, som gælder fra kobsdatoen ved visning af kassebonen. Garantien består i at udskifte de defekte dele. Garantien dækker ikke fejl opstået som følge af anvendelse, som ikke overholder standarderne for apparatet, eller skader opstået ved ikke autoriserede indgreb eller sløsethed fra brugerens side. Garantien dækker ikke skader opstået, fordi værktøjet har svigtet.

RO. GARANȚIE

Acest aparat este garantat din punct de vedere contractual împotriva tuturor viciilor de construcție și de material, începând de la data vânzării lui către utilizator și la simpla prezentare a bonului de casă. Garanția constă în înlocuirea componentelor defecte. Această garanție nu se aplică în cazul exploataării în alt mod decât cel recomandat de normele aparatului și nici în caz de stricăciuni provocate de intervenții neautorizate sau prin neglijența cumpărătorului. Garanția nu se aplică asupra pagbelor cauzate de o defectare a aparatului.

RU. ГАРАНТИЯ

Данное изделие обладает имеющей силу контракта гарантией, покрывающей все возможные дефекты изготовления и материала. Гарантия вступает в силу с даты продажи изделия пользователю, для этого достаточно сохранить и предъявить полученный в кассе чек. Гарантия обязывает изготовителя заменить дефектные части изделия. В случае не соответствующего нормам использования изделия, несанкционированного демонтажа или ремонта или небрежного обращения действие гарантии прекращается. Гарантия не покрывает ущерба, возникшего в результате сбоев в работе изделия.

TU. GARANTI

Bu araç, satış tarihinden itibaren, kullanıcının sadece vezne alındısını sunmasıyla tüm üretim ve malzeme hatasına karşı garantilidir. Garanti eksik olan kısımları değiştirir. Bu garanti aracın şartlarına uygun olmayan işleme durumunda, izin verilmeyen kullanımlardan kaynaklanan hasarlarda veya alıcının isteği durumunda uygulanmaz. Garanti malzemenin bir eksikliğinden meydana gelen bir zararda uygulanmaz.

CS. ZÁRUKA

Pro tento nástroj platí smluvní záruka na všechny výrobní a materiálové vady od data prodeje uživateli a na základě předložení pokladního bloku. Záruka spočívá ve výměně vadných částí. Tato záruka neplatí v případě použití přístroje, které neodpovídá normám, ani v případě škod způsobených nepovolenými zásahy nebo nedbalostí ze strany kupujícího. Záruka se nevztahuje na škody způsobené závadou nástroje.

SK. ZÁRUKA

Pre tento nástroj platí zmluvná záruka na všetky výrobné a materiálové chyby od dátumu predaja užívateľovi a na základe predloženia pokladničného bloku. Záruka spočíva vo výmene chybných častí. Táto záruka neplatí v prípade použitia prístroja, ktoré nezodpovedá normám, ani v prípade škôd spôsobených nepovolenými zásahmi alebo nedbalosťou zo strany kupujúceho. Záruka sa nevzťahuje na škody spôsobené poruchou nástroja.

HE. חריות

הי עלכלי זה חלה אחריות לפי חוזה מופני כל ליקוי ביצור או בחומר, החל מיום המכירה למשתמש עם הצגת חשבונית קופה. האחריות-משמעה החלף תחלקם הלקויים אחריות זו אינה חלה במקרה של שימוש במכשיר שאינו מתאים לתקנים ובמקרה של נזק שנגרם על ידי התערבות תלאל מסכות או על ידי רשלנות מאת הקונה. האחריות אינה חלה על נזק שנגרם על ידי תקלה בכלי.

AR. الضمان

إن هذه الة مضمونة تعاقدياً من أي عيب فني التحسيني عوفى المواد، إعتباراً من تاريخ البيع إلى المشتري ومنه على مجرد تقديم بطاقة الشراء. يتعلّق الضمان ففای ستبدال الأجزاء الةاطلة لآ يكون هذا الضمان قابلاً للتطبيق في حالة الأستخدام غير المطابق لمعايير الأجهار، ولما في حالة تعرضه لآتلفاقت ناتجة عن عملیات تدخّل غير مرخصة أو في حالة الأفعال من قبل المشتري لآ يطبق الضمان على الأضرار الناتجة عن غل

HU. GARANCIA

Erre a szerszámra szerződéses garanciát vállalunk bármilyen gyártási és anyaghiba felmerülése esetére, a fogyasztó részére történt eladás napjától számítva, a pénzérti blokk egyszerű felmutatása ellenében. A garancia a hibás alkatrészek cseréjére terjed ki. Ez a garancia nem érvényes, ha a készüléket nem rendeltetésszerűen használták, sem illetéktelen beavatkozások, vagy a vásárló hanyagsága okozta károk esetén. A garancia nem fedezi azokat a károkat, melyeket a szerszám hibás működése okozott.

SL. GARANCIJA

To orodje je z garancijsko pogodbo zaščiteno proti vsem napakam v izdelavi in v sestavnem materialu od datuma prodaje naprej in ta velja ob predložitvi blagajniškega računa. Garancija velja za zamenjavo delov z napaka. Ta garancija ne velja za uporabo orodja, ki ni v skladu z normami, predpisanimi za omenjeno orodje in za primere okvar, ki nastanejo zaradi nedovoljenih posegov na orodju ali zaradi malomarnega rokovanja kupca. Garancija ne velja za škodo, ki jo lahko povzroči okvara orodja.

ET. GARANTII :

See tööriist kuulub lepingu järgi garantiiremonti arvestades alates müümise päevast ja kasutatavale kõigi konstruktsiooni- ja materjalivigade puhul. Garantii seisneb defektsete osade väljavahetamises. See garantii ei kehti aparaadi normide ebatavalise eiramise puhul ega ostja poolt keelatud viisil kasutamist või hooletussejätmisest tulenevate kahjude korral. Garantii ei kehti seadme defektidest põhjustatud kahjude puhul

LV. GARANTIJA :

Šis prietaisas yra užtikrinamas kaip itin geros kokybės, nuo jo pardavimo datos iki jo panaudojimo, ir jam yra suteikiamas garantinis talonas. Garantijos metu galima pakeisti atsiradusius trumplataikius gedimus. Ši garantija netaikoma esant netinkamam naudojimui ar nesilaikant reikiamų šio aparato vartojimo instrukcijų, tai pat pačiam pirkeiui jį sugadinus. Garantija taip pat netaikoma, prietaisą naudojant ne pagal paskirtį ir jį apgadinus

LT. GARANTIJA :

Šim darbarikam ir ligumä noteika garantija visiem defektiem, kas saistäs ar konstrukciju un materiälu, säkot ar pärdošanas datumu, kad mašinu pärdod lietotäjam un vienkärsi uzrädot kases äeku. Garantija iekļauj bojäto daļu nomaiņu. Ši garantija nav derīga, ja aparčs nav lietots saskaņä ar drošības noteikumiem, ne gadījumos ja bojājumi radušies nesankcionētās iejaukšanās gadījumā vai arī pierčēja nolaidības dēļ. Garantija nav derīga, ja bojājumi radušies darbarika defekta dēļ

HR. JAMSTVO

Ovaj alat ima ugovorno jamstvo u slučaju bilo kakvih nedostataka u konstrukciji i materijalu, od datuma prodaje korisniku uz jednostavno predocenje računa. Jamstvo se sastoji u zamjeni neispravnih dijelova. Ovo se jamstvo ne primjenjuje u slučaju uporabe i eksploatacije koja nije sukladna standardima uređaja, niti u slučaju štete uzrokovane neovlaštenim intervencijama ili nemanom kupca. Jamstvo se ne primjenjuje na štetu uzrokovanu nekim nedostatkom alata.

